



**maxema<sup>®</sup>**

**CATALOGUE**





Made  
in Italy



Prodotto  
in Italia

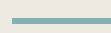

Fabriqué  
en Italie



Fabricado  
en Italia





F1 – C CR	118
F1T – GOM C CR	120
F1T – GOM CB CR	122
F1T – GOM 30 CR	124

<b>Technical information</b>	126
informazioni tecniche	

**Dot** 128

retractable / meccanismo a scatto

D1 – MATT B	130
D1 – MATT CB	132
D1 – MATT	134
D1 – MATT K	136
D1 – MATT F	138
D1 – B CR	140
D1 – CB CR	142
D1 – C CR	144
D1 – 30 CR	146
D1 – GOM K	148
D1 – GOM CB CR	150
D1 – GOM C CR	152
D1 – GOM 30 CR	154
D1 – C GOLD	156
D1 – GOM KF CR	157
<b>D1 – MATT CB RE</b>  POST-CONSUMER RECYCLED PLASTIC	158
<b>D1 – MATT RE</b>  POST-CONSUMER RECYCLED PLASTIC	160
<b>D1 – MATT CB AB</b>  ANTIBACTERIAL PLASTIC	162

<b>Technical information</b>	165
informazioni tecniche	

**Zink** 166

twist-action / meccanismo a rotazione

Z1 – CB	168
Z1 – C	170
Z1 – 30	172
Z1 – CF	174
<b>Z1 – CB RE</b>  POST-CONSUMER RECYCLED PLASTIC	176
<b>Z1 – C RE</b>  POST-CONSUMER RECYCLED PLASTIC	178
<b>Z1 – C AB</b>  ANTIBACTERIAL PLASTIC	180

<b>Technical information</b>	183
informazioni tecniche	

**View** 184

twist-action / meccanismo a rotazione

V1 – C CR / V1 – C CR T	186
V1 – 30 CR / V1 – 30 CR T	188
V1 – AL CR / V1 – AL CR T	189
V1 – GOM C CR /	190
V1 – GOM C CR T	190

<b>Technical information</b>	193
informazioni tecniche	

**Tag** 194

twist-action / meccanismo a rotazione

TA1 – MATT AL B	196
TA1 – B CR	198
TA1 – C CR	200

<b>Technical information</b>	203
informazioni tecniche	

**Icon** 204

twist-action / meccanismo a rotazione

IC400 – MATT AL	206
IC400 – C CR	208
IC400 – 30 CR	210
IC400 – C GOLD	212
IC400 – AL CR	213

<b>Technical information</b>	215
informazioni tecniche	

**Ethic** 216



twist-action / meccanismo a rotazione

ET900 – MULTICOLOUR	218
ET900 – FLAG	219
ET900 – C FLAG	219
ET900 – B	220
ET900 – BC	221
ET900 – C CR	222
ET900 – C GOLD	223

<b>Technical information</b>	225
informazioni tecniche	

**Pixel** 226

retractable / meccanismo a scatto

PX40 – MATT CB	228
PX40 – MATT	230
PX40 – MATT CR	232
PX40 – B	234
PX40 – C	235
PX40 – 30	236
PX40 – FROST NEUTRAL	237
PX40 – FROST	238
PX40 – GOM C CR	240
PX40 – GOM 30 CR	241
<b>PX40 – MATT CB RE</b>  POST-CONSUMER RECYCLED PLASTIC	242
<b>PX40 – MATT RE</b>  POST-CONSUMER RECYCLED PLASTIC	244
<b>PX40 – MATT CB AB</b>  ANTIBACTERIAL PLASTIC	246

<b>Technical information</b>	249
informazioni tecniche	

**Bay** 250

twist-action / meccanismo a rotazione

B500 – MATT BC	252
B500 – MATT	254
B500 – BC	256
B500 – C	257
B500 – 30	258
B500 – FROST	259
<b>B500 – MATT RE</b>  POST-CONSUMER RECYCLED PLASTIC	260
<b>B500 – C AB</b>  ANTIBACTERIAL PLASTIC	262

<b>Technical information</b>	265
informazioni tecniche	

**More about Maxema** 266

Scopri di più su Maxema

**Fast and reliable** 270

Veloci e affidabili

**Pens customisation** 272

Personalizzazione penne

**Cases** 280

Astucci

**Cases customisation** 290

Astucci su misura

**Sample sets** 292

Campionari

**Colour palette** 304

Palette colori

**Inks and refills** 306

Inchiostri e refill

**Download the PDF version**

Scarica la versione PDF

→





# Quality, not quantity.

This attitude has guided our journey every step along the way for over thirty years. Driven by our responsibility and the unrelenting desire to improve, we seek quality through innovation, creating writing instruments capable of conveying sustainable ideas and messages, able to leave a lasting mark.

Qualità, non quantità. Questa è l'attitudine che, da oltre trent'anni, guida il nostro percorso e definisce i nostri passi. Mossi dalla responsabilità e dalla voglia di migliorarci costantemente, ricerchiamo la qualità attraverso l'innovazione, per creare strumenti di scrittura capaci di diventare portatori di idee e messaggi sostenibili, in grado di lasciare un segno duraturo.

# Every choice we make outlines the future.

Ogni scelta che facciamo delinea il futuro.



Every Maxema pen is made in Italy and is the outcome of extensive research and a production process that focuses on detail. **We choose safe, non-toxic materials**, favouring Italian and European suppliers to guarantee durable and reliable products. For us, a pen is not just an instrument. It is a medium for stories, commitment and values. We believe that even a pen can help us write a better tomorrow.

That's why our collection includes product lines made from recycled raw materials such as **post-consumer ABS plastic, R-PET** and **post-industrial recycled (PIR) ABS plastic**. We have also always recovered and reused scraps from plastic processing.

Our commitment to sustainability has led us to work with partners who share our goals, such as **Oceanworks, ClimatePartner, Alperia** and **Plastic Bank**, all trusted organisations that guarantee a transparent, certified supply chain for their products and services.

Ogni penna Maxema è realizzata in Italia ed è frutto di una lunga ricerca e di un processo produttivo curato in ogni dettaglio. **Scegliamo materiali sicuri e atossici, privilegiando fornitori italiani ed europei, per garantire prodotti durevoli e affidabili**. Per noi, una penna non è solo uno strumento. È veicolo di storie, impegno e valori. Crediamo che, anche attraverso una penna, si possa contribuire a scrivere un domani migliore. Per questo abbiamo inserito nella nostra collezione linee prodotte con materie prime riciclate come la plastica **ABS Post Consumo**, l'**R-PET** e la plastica **ABS PIR (Post-Industrial Recycled)** e da sempre recuperiamo e riutilizziamo gli sfridi di lavorazione della plastica.

Il nostro impegno per una produzione più sostenibile ci ha portato a selezionare partner che condividono i nostri stessi obiettivi come **Oceanworks, ClimatePartner, Alperia** e **Plastic Bank**, realtà affidabili che garantiscono una filiera trasparente e certificata per i loro prodotti e servizi.

Tomorrow is like a blank sheet of paper ready to be filled with our ideas and goals.

Our commitment to protecting the environment is an invitation to act together: we want to inspire companies and individuals to write a better future and choose products that respect the planet and people. Because only by sharing visions and responsibilities can we really write a beautiful story. A story that will stand the test of time.

Il domani è come un foglio bianco, pronto ad essere riempito con le nostre idee e i nostri obiettivi. Il nostro impegno a tutela dell'ambiente è un invito ad agire insieme: vogliamo ispirare aziende e persone a scrivere un futuro migliore e scegliere prodotti che rispettino il pianeta e le persone. Perché solo condividendo visioni e responsabilità possiamo davvero scrivere una bella storia. Una storia capace di durare nel tempo.



# We use only energy from renewable sources

Usiamo solo energia da fonti rinnovabili.



EN

Change starts with our choices.  
In cooperation with the Alperia Group,  
**we only use energy from renewable sources**, namely hydroelectric power stations in South Tyrol.

IT

Il cambiamento inizia dalle nostre scelte.  
In collaborazione con Alperia Group, **usiamo solo energia proveniente da fonti rinnovabili**, per la precisione da centrali idroelettriche dell'Alto Adige.





# We want to reduce our carbon footprint.

Vogliamo ridurre la nostra impronta di carbonio.



ClimatePartner  
certified company  
[climate-id.com/94EEJU](https://climate-id.com/94EEJU)



plasticbank®



EN

## Our company is ClimatePartner certified.

To deliver our commitment in transparent fashion, we have calculated Maxema's corporate carbon footprint and defined new targets and ways to help reduce it. We know, however, that there will always be emissions that we cannot avoid or reduce. To offset these, we have chosen to fund a climate protection initiative in association with the **Plastic Bank** project, an organisation that provides a stable income for groups of people who commit to removing plastic from coast-lines and oceans. The material collected is then turned into raw material for re-use in other products and packaging, so contributing to the circular economy.

IT

## La nostra azienda è certificata ClimatePartner.

Per comunicare in modo trasparente il nostro impegno abbiamo calcolato l'impronta di carbonio aziendale di Maxema e definito nuovi obiettivi e modalità per contribuire a ridurla. Sappiamo, però, che ci saranno sempre delle emissioni che non potremo evitare o diminuire. Per compensarle, abbiamo scelto di sostenere finanziariamente un'iniziativa di protezione del clima abbinato al progetto **Plastic Bank**, un'organizzazione che permette un reddito stabile a gruppi di persone che si impegnano ad eliminare la plastica dalle coste e dagli oceani. Il materiale raccolto viene poi trasformato in materia prima per essere riutilizzato in altri prodotti e imballaggi, contribuendo all'economia circolare.



Tante penne, infinite storie. Scrivi la tua.

**Many pens,  
endless stories.**

**Write yours.**

# Zed

---



 PIR RECYCLED  
PLASTIC

Restart from the end. Restart from Zed.  
*Riparti dalla fine. Riparti da Zed.*

---

Sharp design,  
circular message.

*Design affilato,  
messaggio circolare.*

---

**Download Post-Industrial  
Recycled ABS Catalogue**

→

Scarica il catalogo Post-Industrial  
Recycled ABS



---

Technical information at p. 29  
*Informazioni tecniche a pag. 29*

---

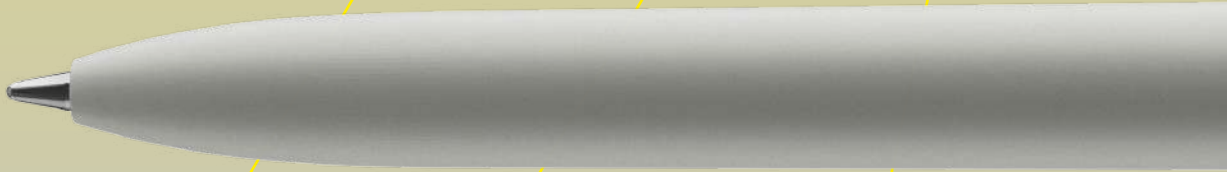

# Last letter. Design first.



EN

An understated design with a bold profile and unprecedented scope for customisation. Zed is our model made of certified, traceable post-industrial recycled (PIR) ABS plastic. A pen with a strong character, combining a perfect balance of form and function. Designed to restore value to what remains at the end of the production cycle. Write a new story starting from the end, restart from Zed.

IT

Un design essenziale dal profilo grintoso e uno spazio di personalizzazione senza precedenti. Zed è il nostro modello in plastica ABS riciclata post industriale (PIR), certificata e tracciata. Una penna dal carattere deciso, che unisce forma e funzione in un equilibrio perfetto. Pensata per restituire valore a ciò che resta alla fine del ciclo di produzione. Scrivi una nuova storia partendo dalla fine, inizia da Zed.

# PIR plastic: end of waste, start of reuse.

Plastica PIR: fine dello spreco, inizio del riuso.

EN

PIR (Post-Industrial Recycled) ABS plastic is created from the waste generated by the production process: a recycled material obtained from plastics that never reached the market. This material offers excellent performance and a high level of purity, significantly more sustainable than virgin plastic: it reduces energy consumption, limits CO<sub>2</sub> emissions and enhances what already exists.

IT

Dagli sfridi generati durante i processi produttivi, nasce la plastica ABS PIR (Post-Industrial Recycled): un materiale riciclato ottenuto da plastiche che non hanno mai raggiunto il mercato. Questo materiale offre ottime prestazioni e un livello di purezza elevato, notevolmente più sostenibile rispetto alla plastica vergine: riduce i consumi energetici, limita le emissioni di CO<sub>2</sub> e valorizza ciò che esiste già.



Solid colours barrel with matt finish, solid matt white colour cap.

Brand visibility enhanced with the white clip.



03



18



16



15



79



09

23 violet / pad printing 47 x 9 mm  
23 viola / tampografia 47 x 9 mm

Z8

MATT CB PIR

*Fusto in colore coprente con finitura satinata, cappuccio in colore bianco coprente satinato.*

Brand più  
in evidenza  
con la clip  
bianca.

27 octan green / pad printing 47 x 9 mm  
27 ottanio / tampografia 47 x 9 mm



75

77

12

05

11

04

22 blue / pad printing 47 x 9 mm  
22 blu / tampografia 47 x 9 mm

Solid colours with matt finish.

Designed  
to stand out.

16 bright red /  
pad printing 47 x 9 mm  
16 rosso vivo /  
tampografia 47 x 9 mm



01



03



18



15



23



79



09

Z8

MATT PIR

Colori coprenti con finitura satinata.

Progettata  
per distinguersi.



75



27



77



12



22



05



11 dark grey /  
pad printing 47 x 9 mm  
11 grigio scuro /  
tampografia 47 x 9 mm



04

Technical information  
*Informazioni tecniche*

# Zed Post-Industrial Recycled

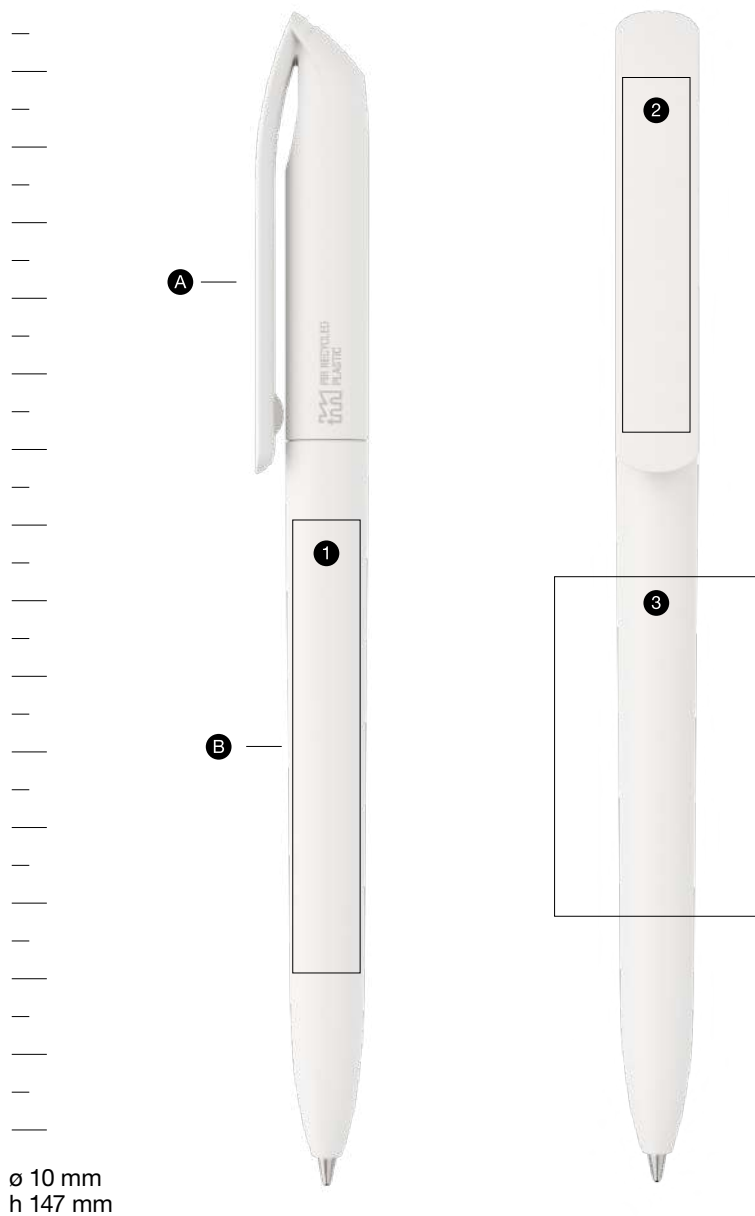

## Components / Componenti

- Ⓐ Cap / cappuccio
- Ⓑ Barrel / fusto

## Print area / Area stampabile

- ① pad printing / tampografia  
60 x 9 mm
- ② pad printing / tampografia  
47 x 9 mm
- ③ screen printing / serigrafia  
45 x 27 mm

## Features / Caratteristiche

twist-action / meccanismo a rotazione

Made from certified and traceable post-industrial recycled ABS plastic (PIR) / Realizzata in plastica ABS riciclata post-industriale (PIR) certificata e tracciata

Made of 90% PIR plastic in the following colours: 01 white, 05 grey, 11 dark grey, 04 black. PIR plastic content is 80% for all other available colours / Prodotta con il 90% di plastica PIR nei seguenti colori: 01 bianco, 05 grigio, 11 grigio scuro, 04 nero. Per tutti gli altri colori disponibili il contenuto di plastica PIR è l'80%

Jumbo refill, blue and black ink / refill Jumbo, inchiostro blu e nero

available in matt finish / disponibile con superfici satinata



Small imperfections and slight colour variations are to be considered intrinsic features of the PIR ABS plastic. / Piccole imperfezioni e lievi variazioni cromatiche sono da considerarsi caratteristiche intrinseche della plastica ABS PIR.

# Kind

---

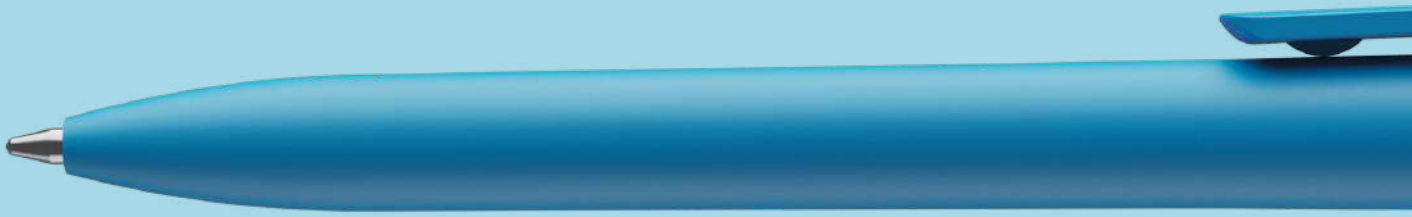

Message from a bottle.  
*Messaggio da una bottiglia.*

---

Created to  
write change.

*Realizzata per scrivere  
il cambiamento.*



---

**Download  
R-PET  
catalogue**

→

Scarica il catalogo R-PET



---

Technical information at p. 49  
*Informazioni tecniche a pag. 49*

---



# Maxema chooses OCEANWORKS®

Maxema sceglie OceanWorks®

EN

Less talk, more facts. It is not enough for us to convey sustainable messages, we want to be an active part of a wave of change. That's why we have decided to partner with Oceanworks, a global platform committed to reducing plastic pollution in our oceans. Through a network of collectors and collaborators, it provides recycled and certified materials, guaranteeing transparency and traceability in the supply chain, from the origins of the plastic waste to the final product. Together we have produced the Kind, made of **R-PET plastic sourced exclusively from ocean-bound clean-ups.**

A concrete choice to reduce our environmental footprint and offer you a truly sustainable promotional tool.

IT

Meno parole, più fatti. Non ci basta trasmettere messaggi sostenibili, vogliamo essere parte attiva di un'onda di cambiamento. Per questo abbiamo scelto di collaborare con Oceanworks, una piattaforma globale impegnata a ridurre l'inquinamento da plastica negli oceani. Attraverso una rete di raccoglitori e collaboratori in tutto il mondo, fornisce materiali riciclati e certificati, garantendo trasparenza e tracciabilità nella supply chain, dall'origine dei rifiuti plastici fino alla produzione finale. Insieme abbiamo realizzato Kind, prodotta con materiale plastico **R-PET proveniente esclusivamente da attività di pulizia delle coste oceaniche.** Una scelta concreta per ridurre la nostra impronta ambientale e darti uno strumento promozionale realmente sostenibile.



# 100% R-PET Pens

Penne in 100% R-PET



EN

The Kind is our pen made from **100% recycled PET**, a material sourced from plastic bottles collected by Oceanworks, a globally active organisation specialising in recycling ocean-bound plastic, with whom we have formed an exclusive partnership.

IT

Kind è la nostra penna in **100% PET riciclato**, un materiale recuperato dalle bottiglie di plastica raccolte lungo le coste oceaniche da Oceanworks, un'organizzazione attiva a livello mondiale per promuovere soluzioni circolari per la plastica, con la quale abbiamo stretto una partnership esclusiva.

**Scan the  
QR Code  
and Be Kind.**

Scannerizza  
il QR code  
e Be Kind.



# R-PET reduces emissions

Il materiale R-PET riduce le emissioni



EN

R-PET helps reduce environmental impact: studies have found that its use **saves 50% of CO<sub>2</sub> compared to virgin PET.**

IT

Il materiale R-PET contribuisce a ridurre l'impatto ambientale: secondo gli studi, il suo utilizzo **consente di risparmiare il 50% di CO<sub>2</sub> rispetto all'uso di PET vergine.**

Source/Fonte: Oceanworks

**Download  
R-PET  
catalogue**



Scarica il  
catalogo R-PET





K1 MATT CB RP

Solid colour barrel with matt finish,  
solid matt white colour clip  
and push-button

White clip: ideal  
for multicolour  
brands.

18 orange / pad printing  
32 x 7 mm  
18 arancio / tampografia  
32 x 7 mm



03



15



79



09 green / pad printing 32 x 7 mm  
09 verde / tampografia 32 x 7 mm

## K1 | MATT CB RP

*Fusto in colore coprente con finitura satinata, clip e tappino in colore bianco coprente satinato*

Clip bianca:  
ideale per i brand  
a più colori.



75



77



12



05



04

22 blue / pad printing 32 x 7 mm  
22 blu / tampografia 32 x 7 mm

K1 MATT RP

Solid colours with matt finish

Strong visual impact, low environmental impact.

15 red / pad printing 32 x 7 mm  
15 rosso / tampografia 32 x 7 mm



03



18



79



09

01 white / pad printing 32 x 7 mm  
01 bianco / tampografia 32 x 7 mm

K1 | MATT RP

*Colori coprenti con finitura satinata*

Alto impatto  
visivo, basso  
impatto  
ambientale.



77

12

22

05

04

75 dark green / pad printing 32 x 7 mm  
75 verde scuro / tampografia 32 x 7 mm

K1 | GOM MATT CB RP

Solid colour barrel with rubber finish, solid white colour clip and push button

Soft touch,  
safe grip.



03



18



15



09

79 lime / pad printing 32 x 7 mm  
tampografia 32 x 7 mm

Extra customisation is available to tell the story of this pen's origin. Info at page 268

*Disponibile una personalizzazione extra per raccontare l'origine di questa penna. Info a pag. 268*

## K1 | GOM MATT CB RP

*Fusto in colore coprente gommato,  
clip e tappino in colore bianco  
coprente satinato*

Morbida al tatto,  
grip perfetto.

77 cyan / pad printing 32 x 7 mm  
77 ciano / tampografia 32 x 7 mm



75



12



22



05



04 black / pad printing 32 x 7 mm  
04 nero / tampografia 32 x 7 mm

K1 | GOM MATT RP

18 orange / pad printing 32 x 7 mm  
 18 arancio / tampografia 32 x 7 mm

Solid colour barrel with rubber finish, solid colour clip and push button with matt finish

Per Kind è disponibile l'astuccio My Case dedicato. Scoprilò a pag. 276.



01



03



15



79



09 green / pad printing 32 x 7 mm  
 09 verde / tampografia 32 x 7 mm

## K1 | GOM MATT RP

*Fusto in colore coprente gommato,  
tappino e clip in colore coprente  
satinato*

The dedicated My  
Case pen box is  
available for the  
Kind. Learn more  
on page 276.



75



77



22



05



04

12 light blue / pad printing 32 x 7 mm  
12 azzurro / tampografia 32 x 7 mm

K1 | FROST RP

Transparent colours  
with matt finish

Transparent  
is cool!



39



52 yellow / pad printing 32 x 7 mm  
52 giallo / tampografia 32 x 7 mm



53



45



55

K1 | FROST RP

*Colori trasparenti  
con finitura satinata***Trasparente  
è cool!**49 green / pad printing 32 x 7 mm  
49 verde / tampografia 32 x 7 mm

78



67



44



32

50 dark grey / pad printing 32 x 7 mm  
50 grigio scuro / tampografia 32 x 7 mm

Technical information  
*Informazioni tecniche*

# Kind R-PET

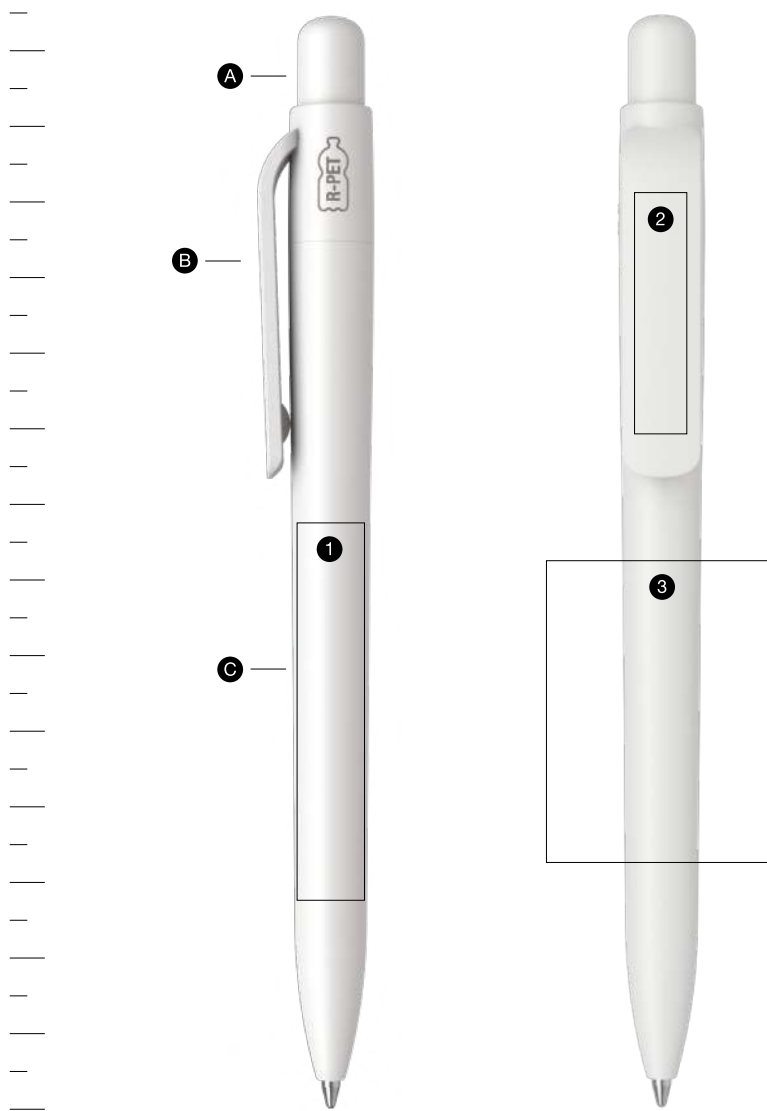

ø 10 mm  
h 141,5 mm

## Components / Componenti

- Ⓐ Push-button / *tappino*
- Ⓑ Clip
- Ⓒ Barrel / *fusto*

## Print area / Area stampabile

- ① pad printing / *tampografia*  
50 x 9 mm
- ② pad printing / *tampografia*  
32 x 7 mm
- ③ screen printing / *serigrafia*  
40 x 30 mm

## Features / Caratteristiche

retractable /  
*meccanismo a scatto*

Made of certified R-PET collected from ocean-bound regions / *realizzata in R-PET certificato, raccolto dalle zone costiere oceaniche*

Jumbo refill, blue and black ink / *refill Jumbo, inchiostro blu e nero*

the barrel is available in matt and rubber finishes, the clip and the push-button are available in matt finish / *il fusto è disponibile con superfici satinata e gommata, la clip e il tappino sono disponibili con superfici satinata*



R-PET PLASTIC / *PLASTICA R-PET*

Small imperfections and slight colour variations are to be considered intrinsic features of the reuse of recycled PET material. /

*Piccole imperfezioni e lievi variazioni cromatiche sono da considerarsi caratteristiche intrinseche del riutilizzo del materiale PET riciclato.*

# Mood Metal

---



Design with a metal touch.  
*Il design incontra il metallo.*

---

Luxury is a state of mind.  
*Il lusso è un'attitudine.*



Technical information at p. 59  
*Informazioni tecniche a pag. 59*

---

MD1 | M M1

Chrome finish metal barrel, tip and push-button, solid colour clip with glossy finish, solid glossy colour little sphere

Metal details with diamond mirror finish.



01 70 03 18 15

60 61 71 25 72 73

74 burgundy / pad printing 40 x 9 mm  
74 bordeaux / tampografia 40 x 9 mm

All Mood models come with a single My Box case in Fedrigoni Ardesia recycled cardboard included. Info at p. 288

*Tutti i modelli Mood vengono forniti con astuccio singolo My Box in cartoncino riciclato Fedrigoni Ardesia incluso. Info pag. 288*

*Fusto, punta e tappino in metallo con finitura cromata, clip in colore coprente lucido, piccola sfera in colore coprente lucido*

Finitura  
a specchio  
diamantata per  
i particolari  
in metallo.

75 dark green / pad printing 40 x 9 mm  
75 verde scuro / tampografia 40 x 9 mm

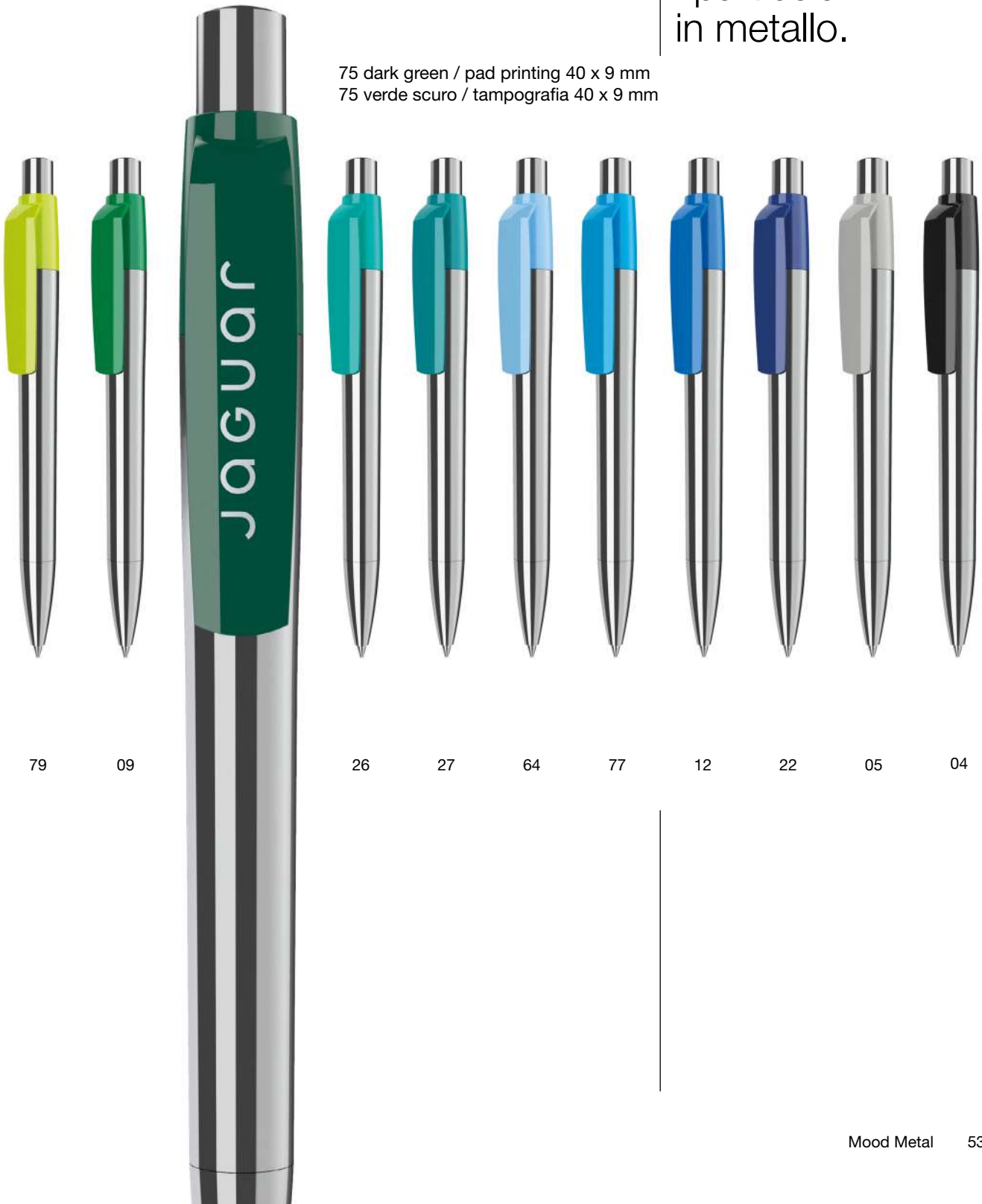

79

09

26

27

64

77

12

22

05

04

MD1 | M M4

Titanium grey finish metal barrel, tip and push-button, solid colour clip with glossy finish, solid glossy colour little sphere

Titanium grey finish: metal in a dynamic version.



70

03

18

15

74

60

71

72

01 white / pad printing 40 x 9 mm  
01 bianco / tampografia 40 x 9 mm

All Mood models come with a single My Box case in Fedrigoni Ardesia recycled cardboard included.  
Info at p. 288

*Tutti i modelli Mood vengono forniti con astuccio singolo My Box in cartoncino riciclato Fedrigoni Ardesia incluso.  
Info pag. 288*

*Fusto, punta e tappino in metallo con  
finitura grigio titanio, clip in colore  
coprente lucido piccola sfera in colore  
coprente lucido*

Finitura grigio  
titanio: il metallo  
in versione  
dinamica.

04 black / pad printing 40 x 9 mm  
04 nero / tampografia 40 x 9 mm



73

79

09

75

27

77

22

05



MD1 | M M2

01 white / pad printing 40 x 9 mm  
01 bianco / tampografia 40 x 9 mm



Gold finish metal barrel, tip and push-button, solid colour clip with glossy finish, solid glossy colour little sphere

Metal with gold finish: pure light.

All Mood models come with a single My Box case in Fedrigoni Ardesia recycled cardboard included. Info at p. 288

*Tutti i modelli Mood vengono forniti con astuccio singolo My Box in cartoncino riciclato Fedrigoni Ardesia incluso. Info pag. 288*



*Fusto, punta e tappino in metallo con finitura dorata, clip in colore coprente lucido, piccola sfera in colore coprente lucido*

Metallo con  
finitura oro: luce  
allo stato puro.

04 black / pad printing 40 x 9 mm  
04 nero / tampografia 40 x 9 mm

Technical information  
*Informazioni tecniche*

# Mood Metal



ø 11,5 mm  
h 141,5 mm



The entire Maxema collection is available  
in post-consumer recycled plastic on request /  
*Tutta la collezione Maxema è realizzabile  
in plastica riciclata post-consumo su richiesta*

## Components / Componenti

- Ⓐ Push-button / tappino
- Ⓑ Clip
- Ⓒ Barrel / fusto
- Ⓓ Tip / punta

## Print area / Area stampabile

- ① laser engraving 30 x 7 mm  
incisione laser 30 x 7 mm
- ② pad printing / tampografia  
40 x 9 mm

## Features / Caratteristiche

retractable with return spring /  
meccanismo a scatto, con molla  
di ritorno

metal push-button, barrel and tip,  
individually processed with diamond  
mirror face finish / tappino, fusto e  
punta in metallo, lavorati singolarmente  
con finitura a specchio diamantata

clip made of non-toxic, highly resistant  
ABS plastic / clip realizzata in plastica  
ABS atossica e ad alta resistenza

“Parker type” refill, blue and black ink /  
refill “tipo Parker”, inchiostro blu e nero

**Fast Dry Gel** blue and black ink available  
on request /  
*Refill Gel Fast Dry blu e nero disponibile  
su richiesta*

# Mood

---

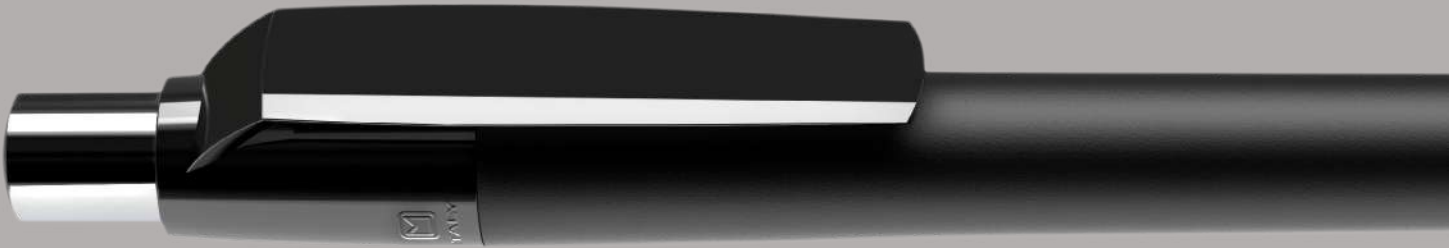

Exclusive and refined.  
*Esclusiva e raffinata.*

---

Elegance leaves its mark.  
*L'eleganza lascia il segno.*

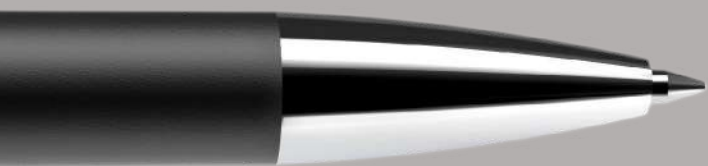

Technical information at p. 73  
*Informazioni tecniche a pag. 73*

---

MD1 | C M1

Solid colours with glossy finish,  
chrome finish metal tip and push-  
button, solid glossy colour little sphere



01

70

03

18

15

60

61

71

25

72

74 burgundy / pad printing 40 x 9 mm  
74 bordeaux / tampografia 40 x 9 mm

All Mood models come with a single  
My Box case in Fedrigoni Ardesia  
recycled cardboard included.  
Info at p. 288

*Tutti i modelli Mood vengono  
forniti con astuccio singolo My Box  
in cartoncino riciclato Fedrigoni  
Ardesia incluso.  
Info pag. 288*

Colori coprenti con finitura lucida,  
punta e tappino in metallo  
con finitura cromata, piccola sfera  
in colore coprente lucido



73

79

09

75

26

64

77

12

22

05

04

27 octan green / pad printing 40 x 9 mm  
27 ottanio / tampografia 40 x 9 mm

MD1 | GOM CB M1

Solid colour barrel with rubber finish, solid glossy white colour clip, chrome finish metal tip and push-button, solid glossy colour little sphere

18 orange / pad printing 40 x 9 mm  
18 arancio / tampografia 40 x 9 mm



03

15

74

61

71

25

72

73

60 pink / pad printing 40 x 9 mm  
60 rosa / tampografia 40 x 9 mm

*Fusto in colore coprente gommato, clip in colore bianco lucido, punta e tappino in metallo con finitura cromata, piccola sfera in colore coprente lucido*

75 dark green / pad printing 40 x 9 mm  
75 verde scuro / tampografia 40 x 9 mm

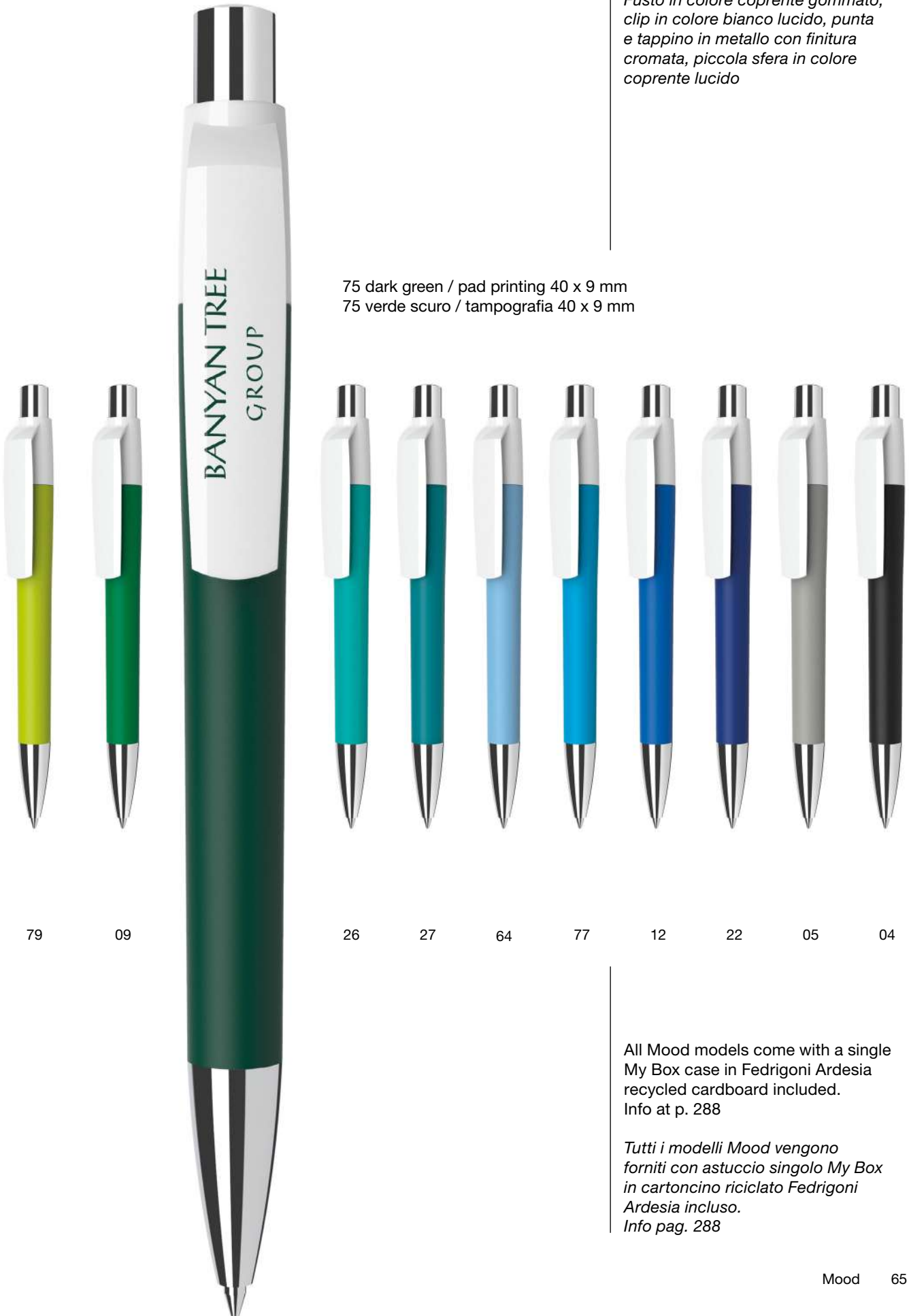

79

09

26

27

64

77

12

22

05

04

All Mood models come with a single My Box case in Fedrigoni Ardesia recycled cardboard included. Info at p. 288

*Tutti i modelli Mood vengono forniti con astuccio singolo My Box in cartoncino riciclato Fedrigoni Ardesia incluso. Info pag. 288*

## MD1 | GOM C M1

Solid colour barrel with rubber finish, solid colour clip with glossy finish, chrome finish metal tip and push-button, solid glossy colour little sphere

Result of superior quality craftsmanship.



70

03

18

15

74

60

61

71

25

72

73

All Mood models come with a single My Box case in Fedrigoni Ardesia recycled cardboard included. Info at p. 288

*Tutti i modelli Mood vengono forniti con astuccio singolo My Box in cartoncino riciclato Fedrigoni Ardesia incluso. Info pag. 288*

*Fusto in colore coprente gommato, clip in colore coprente con finitura lucida, punta e tappino in metallo con finitura cromata, piccola sfera in colore coprente lucido*

Risultato  
di lavorazioni  
artigiane di  
qualità superiore.



79

09

75

26

27

64

77

12

22

05

04 black / pad printing 40 x 9 mm  
04 nero / tampografia 40 x 9 mm



MD1 | GOM 30 M1

Solid colour barrel with rubber finish, transparent colour clip with glossy finish, chrome finish metal tip and push-button, solid glossy white little sphere

31 light violet / pad printing 40 x 9 mm  
31 viola chiaro / tampografia 40 x 9 mm



39



53



45



59



41



55



37

52 yellow / pad printing 40 x 9 mm  
52 giallo / tampografia 40 x 9 mm



38

78 lime / pad printing 40 x 9 mm  
78 lime / tampografia 40 x 9 mm

*Fusto in colore coprente gommato, clip in colore trasparente con finitura lucida, punta e tappino in metallo con finitura cromata, piccola sfera in colore bianco lucido*



49

47

34

67

44

30

50

All Mood models come with a single My Box case in Fedrigoni Ardesia recycled cardboard included. Info at p. 288

*Tutti i modelli Mood vengono forniti con astuccio singolo My Box in cartoncino riciclato Fedrigoni Ardesia incluso. Info pag. 288*



01

04 black / pad printing 40 x 9 mm  
04 nero / tampografia 40 x 9 mm



Solid colours with glossy finish, gold finish metal tip and push-button, solid glossy colour little sphere

*Colori coprenti con finitura lucida, punta e tappino in metallo con finitura dorata, piccola sfera in colore coprente lucido*



All Mood models come with a single My Box case in Fedrigoni Ardesia recycled cardboard included. Info at p. 288

*Tutti i modelli Mood vengono forniti con astuccio singolo My Box in cartoncino riciclato Fedrigoni Ardesia incluso. Info pag. 288*

MD1 | C M3



01

04 black / pad printing 40 x 9 mm  
04 nero / tampografia 40 x 9 mm



Solid colours with glossy finish, rose gold metal tip and push button, solid glossy colour little sphere

*Colori coprenti con finitura lucida, punta e tappino in metallo con finitura oro rosa, piccola sfera in colore coprente lucido*

Rose gold,  
a touch of class  
and uniqueness.

Oro rosa,  
un tocco di  
classe e unicità.

Technical information  
*Informazioni tecniche*

# Mood

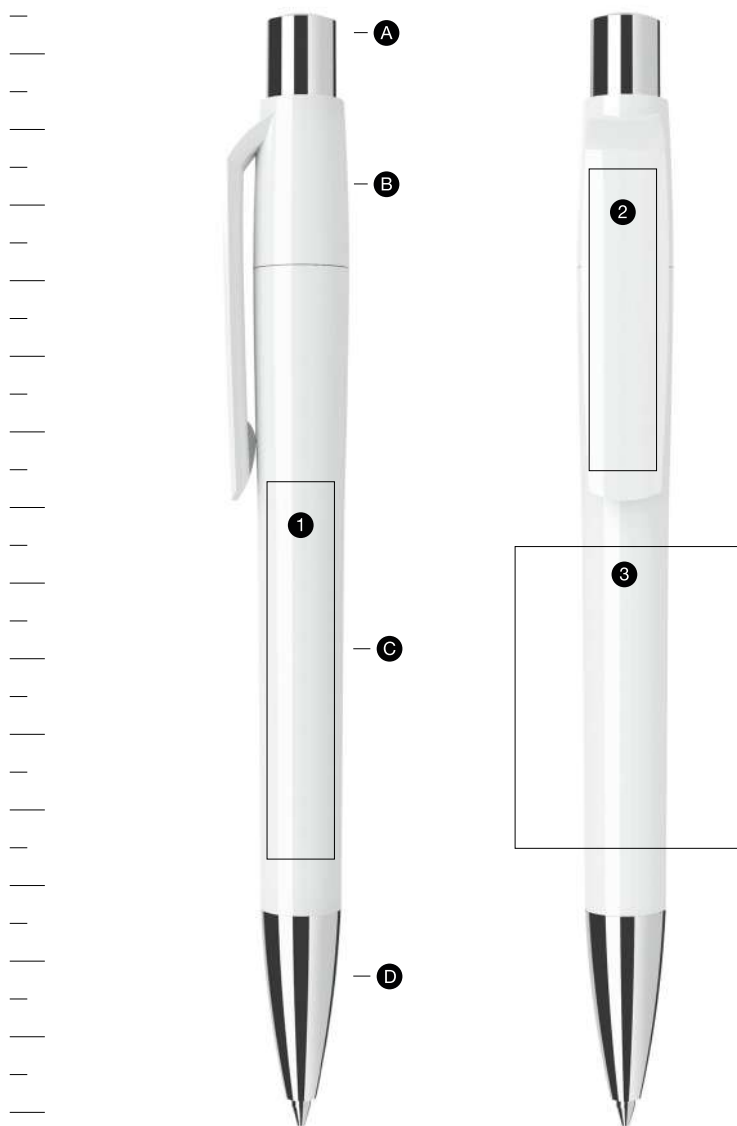

ø 11,5 mm  
h 141 mm



The entire Maxema collection is available  
in post-consumer recycled plastic on request /  
*Tutta la collezione Maxema è realizzabile  
in plastica riciclata post-consumo su richiesta*

## Components / Componenti

- Ⓐ Push-button / tappino
- Ⓑ Clip
- Ⓒ Barrel / fusto
- Ⓓ Tip / punta

## Print area / Area stampabile

- ① pad printing / tampografia  
46 x 9 mm
- ② pad printing / tampografia  
40 x 9 mm
- ③ screen printing / serigrafia  
40 x 30 mm

## Features / Caratteristiche

retractable with return spring /  
meccanismo a scatto, con molla  
di ritorno

made of non-toxic, highly resistant  
ABS plastic / realizzata in plastica ABS  
atossica e ad alta resistenza

metal tip and push-button,  
individually processed with diamond  
mirror face finish / tappino e punta in  
metallo, lavorati singolarmente con  
finitura a specchio diamantata

“Parker type” refill, blue and black ink /  
refill “tipo Parker”, inchiostro blu e nero

available in glossy or rubberised finish /  
disponibile con superfici lucide  
o gommate

**Fast Dry Gel** blue and black ink available  
on request /  
*Refill Gel Fast Dry blu e nero disponibile  
su richiesta*

# Icon Pure

---



The purity of simplicity.  
*La purezza della semplicità.*

---

All-round personality.  
*Personalità a tutto tondo.*



Also available in post-consumer recycled plastic /  
*Disponibile anche in plastica riciclata post-consumo*

---

Technical information at p. 83  
*Informazioni tecniche a pag. 83*

---

IC8 | MATT

Solid colours with matt finish

NEW



01

70

03

18

15

74

60

61

71

25

72

73

Colori coprenti con finitura satinata

NEW

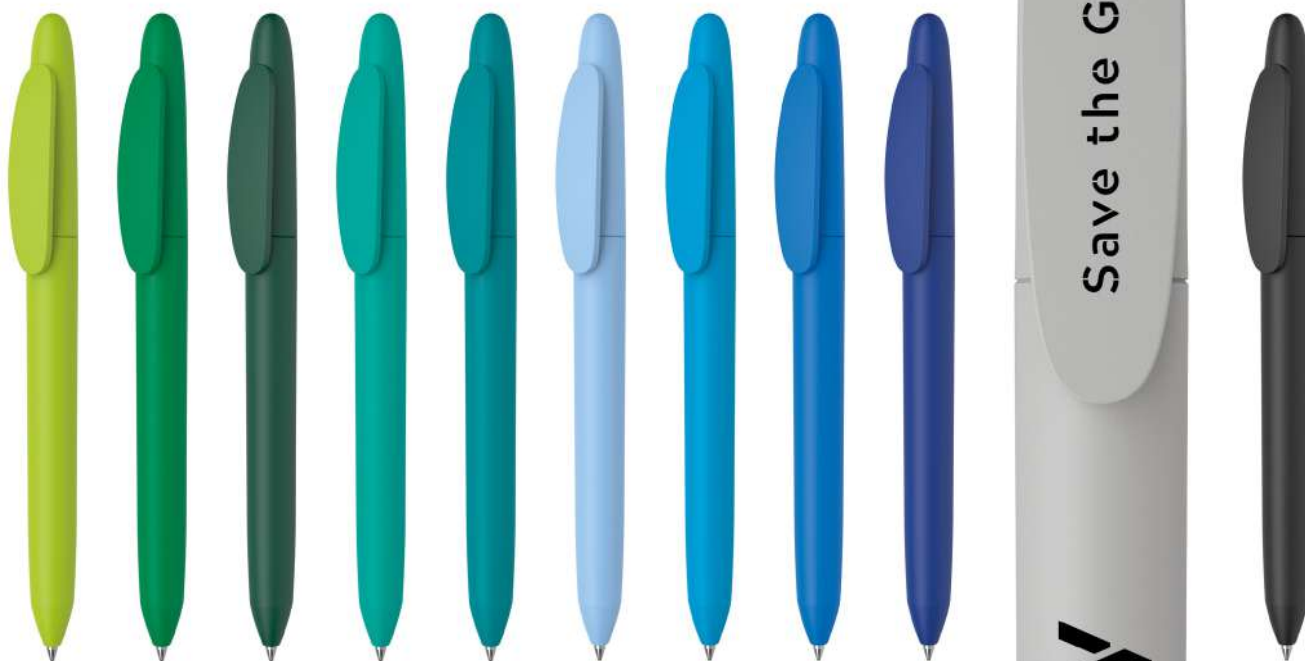

79

09

75

26

27

64

77

12

22

04

05 grey / pad printing 35 x 7 mm  
05 grigio / tampografia 35 x 7 mm

SKYYWAY

Full rubber coating on the entire pen: for printing recommendations, please refer to the technical data sheet on page 70.

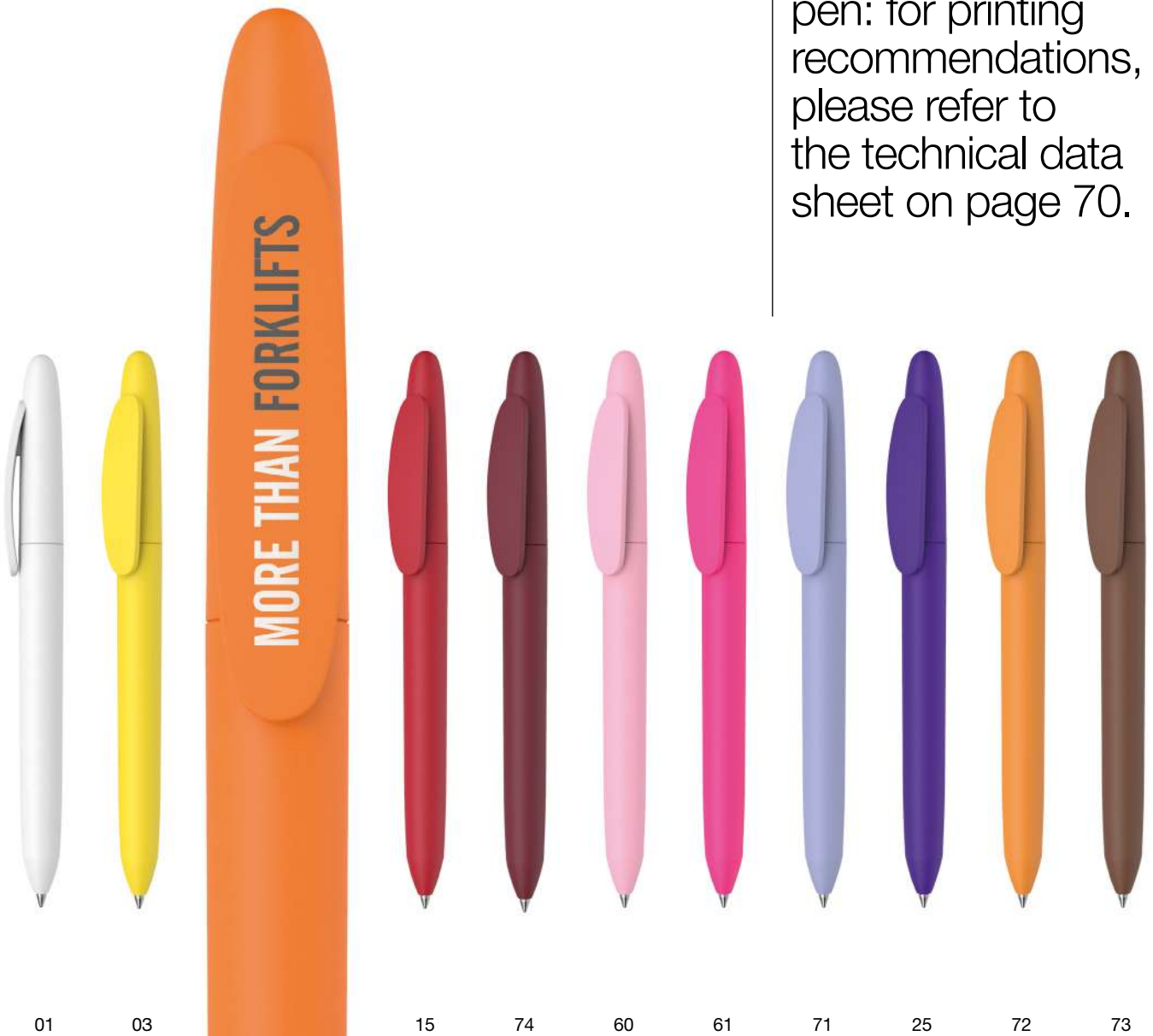

18 orange / pad printing 35 x 7 mm  
18 arancio / tampografia 35 x 7 mm

Colori coprenti con finitura gommata

Gommatura  
integrale su tutta  
la penna: per i  
consigli di stampa  
consultare la  
scheda tecnica  
a pagina 70.

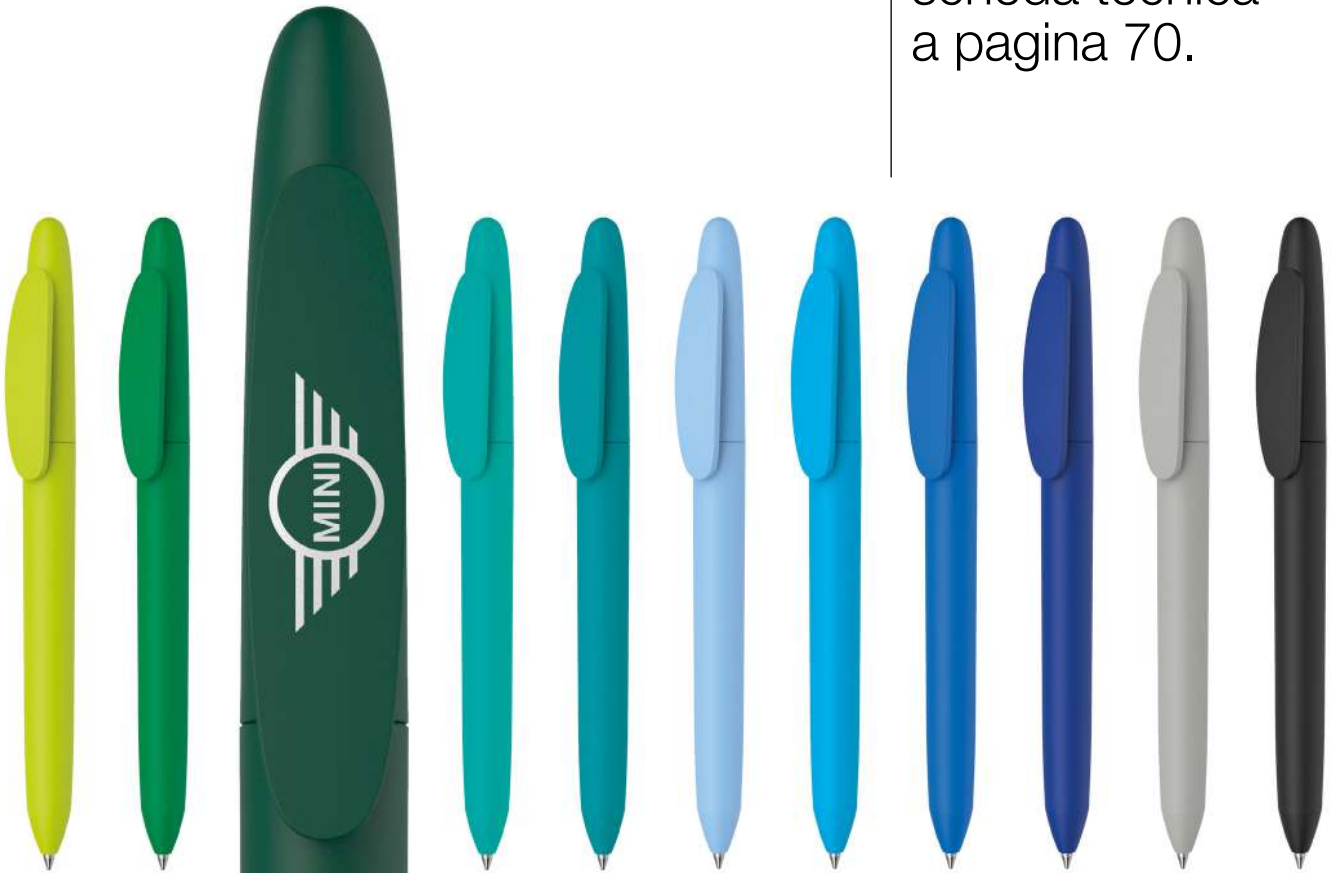

79

09

26

27

64

77

12

22

05

04

75 dark green / pad printing 35 x 7 mm  
75 verde scuro / tampografia 35 x 7 mm



IC8 | MATT RE

RECYCLED PLASTIC POST-CONSUMER

Post-consumer recycled plastic  
Solid colours with matt finish

Made of WEEE  
(Waste of Electrical  
and Electronic  
Equipment)  
recycled plastic.



06



10



76



87 mud / pad printing 35 x 7 mm  
tampografia 35 x 7 mm



Universal reclosable single pen case  
in Fedrigoni recycled paper Ardesia.  
Info at p. 288

*Astuccio universale richiudibile per  
penna singola in cartoncino riciclato  
Fedrigoni Ardesia.  
Info pag. 288*



*Plastica riciclata post-consumo  
Colori coprenti con finitura satinata*

Realizzata in  
plastica riciclata  
da RAEE (Rifiuti  
di Apparecchiature  
Elettriche ed  
Elettroniche).



19

21

58

07 onyx / pad printing 35 x 7 mm  
tampografia 35 x 7 mm

Extra customisation is available to  
tell the story of this pen's origin.  
Info at p. 276

*Disponibile una personalizzazione  
extra per raccontare l'origine di  
questa penna. Info a pag. 276*

**Download  
Post-consumer  
Recycled  
Collection  
Catalogue**

Scarica il catalogo  
Post-consumer  
Recycled  
Collection



Technical information  
*Informazioni tecniche*

# Icon Pure

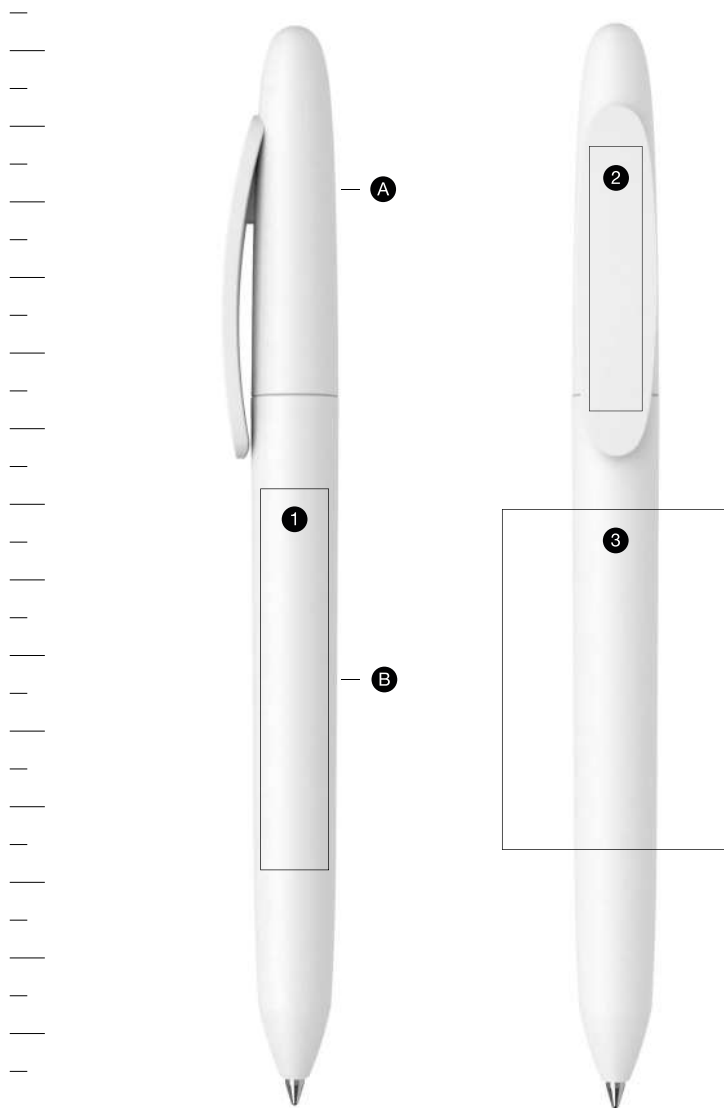

ø 10,2 mm  
h 137 mm



POST-CONSUMER  
RECYCLED PLASTIC

Zink is available  
in post-consumer recycled plastic/  
*La penna Zink è disponibile  
in plastica riciclata post-consumo*

## Components / Componenti

- A** Cap / cappuccio
- B** Barrel / fusto

## Print area / Area stampabile

- 1** pad printing / tampografia  
50 x 9 mm
- 2** pad printing / tampografia  
35 x 7 mm
- 3** screen printing / serigrafia  
45 x 30 mm

## Features / Caratteristiche

twist-action / meccanismo  
a rotazione

made of non-toxic highly resistant  
ABS plastic / realizzata in plastica ABS,  
atossica e ad alta resistenza

Jumbo refill, blue and black ink /  
refill Jumbo, inchiostro blu e nero

available in rubberised and matt finish  
/ disponibile con superfici gommate e  
satinato

printing must be carried out before  
rubber coating or, alternatively,  
using specific inks for rubberised  
surfaces / la stampa deve essere  
eseguita prima della gommatura o, in  
alternativa, con inchiostri specifici per  
superfici gommate

 IC8 – POST-CONSUMER RECYCLED PLASTIC  
PLASTICA RICICLATA POST-CONSUMO

Small imperfections and slight colour variations  
are to be considered intrinsic features of  
the recycled material deriving from the post-  
consumer sector. / Piccole imperfezioni e lievi  
variazioni cromatiche sono da considerarsi  
caratteristiche intrinseche del materiale riciclato  
derivante dal post-consumo.

**Fast Dry Gel** blue and black ink available  
on request /  
*Refill Gel Fast Dry blu e nero disponibile  
su richiesta*

# Flow Pure

---



Free from extra.  
*Pura ed essenziale.*

---

The essence of design.  
*L'essenza del design.*



Also available in post-consumer recycled plastic /  
*Disponibile anche in plastica riciclata post-consumo*



Also available in white antibacterial plastic /  
*Disponibile anche in plastica antibatterica bianca*

---

Technical information at p. 113  
*Informazioni tecniche a pag. 113*

---

F2P | MATT CB

Solid colour barrel and cap, solid white colour clip, matt finishes

Matt finish  
and white clip  
for maximum  
freedom of  
personalisation.



70

03

18

15

74

60

61

71

25

72

73

79

Fusto e cappuccio in colore coprente,  
clip in colore bianco coprente,  
finiture satinat

Finitura matt  
e clip bianca  
per la massima  
libertà di  
personalizzazione.



09

75

26

27

64

77

12

22

04

05 grey / pad printing 40 x 9 mm  
05 grigio / tampografia 40 x 9 mm

All the expressive force of colour in a matt version.



01

70

03

18

15

74

60

61

25

72

73

71 light violet / pad printing 40 x 9 mm  
71 viola chiaro / tampografia 40 x 9 mm

Colori coprenti con finitura satinata

Tutta la forza  
espressiva del  
colore in versione  
satinata.



79

09

75

26

27

64

77

12



05

04

22 blue / pad printing 40 x 9 mm  
22 blu / tampografia 40 x 9 mm

The matt finish  
lights up with  
fluo colours.



02



17



14



Universal single pen case  
in Fedrigoni recycled paper  
Ardesia. Info at p. 280

Astuccio universale  
per penna singola  
in cartoncino riciclato  
Fedrigoni Ardesia.  
Info pag. 280

Colori fluo coprenti  
con finitura satinata

La finitura satinata  
si accende  
con i colori fluo.

FLUO



08

56 fucsia / pad printing 40 x 9 mm  
56 fucsia / tampografia 40 x 9 mm

The colours stand out due to the brilliance of the gloss finish.



01 70 03 18 15 74



60 pink / pad printing 40 x 9 mm  
60 rosa / tampografia 40 x 9 mm



61 71 25 72

*Colori coprenti con finitura lucida*

I colori risaltano grazie alla brillantezza della finitura lucida.



73

79

09

75

26

27

64

77

12

22

05

04



01

03

15

74

60

61

71

25

73

79

18 orange / pad printing 40 x 9 mm  
18 arancio / tampografia 40 x 9 mm

*Fusto e cappuccio in colore coprente  
gommato, clip in colore coprente  
satinato*



09

75

27

64

77

12

22

05

04

26 aquamarine / pad printing 40 x 9 mm  
26 acquamarina / tampografia 40 x 9 mm

F2P | GOM K

Solid black barrel and cap with rubber finish, solid colour clip with glossy finish



70 cream / pad printing 40 x 9 mm  
70 crema / tampografia 40 x 9 mm



03



15



60



61



71



72

18 orange / pad printing 40 x 9 mm  
18 arancio / tampografia 40 x 9 mm

*Fusto e cappuccio in colore  
nero coprente gommato,  
clip in colore coprente lucido*



79

09

27

64

77

12

05

04

26 aquamarine / pad printing 40 x 9 mm  
26 acquamarina / tampografia 40 x 9 mm

F2P | GOM CB

Solid colour barrel and cap with rubber finish, solid white colour clip with glossy finish

60 pink / pad printing 40 x 9 mm  
60 rosa / tampografia 40 x 9 mm



01      03      18      15      74



61



25      73

71 light violet /  
pad printing  
40 x 9 mm  
71 viola chiaro /  
tampografia  
40 x 9 mm

*Fusto e cappuccio in colore coprente  
gommato, clip in colore bianco  
coprente lucido*

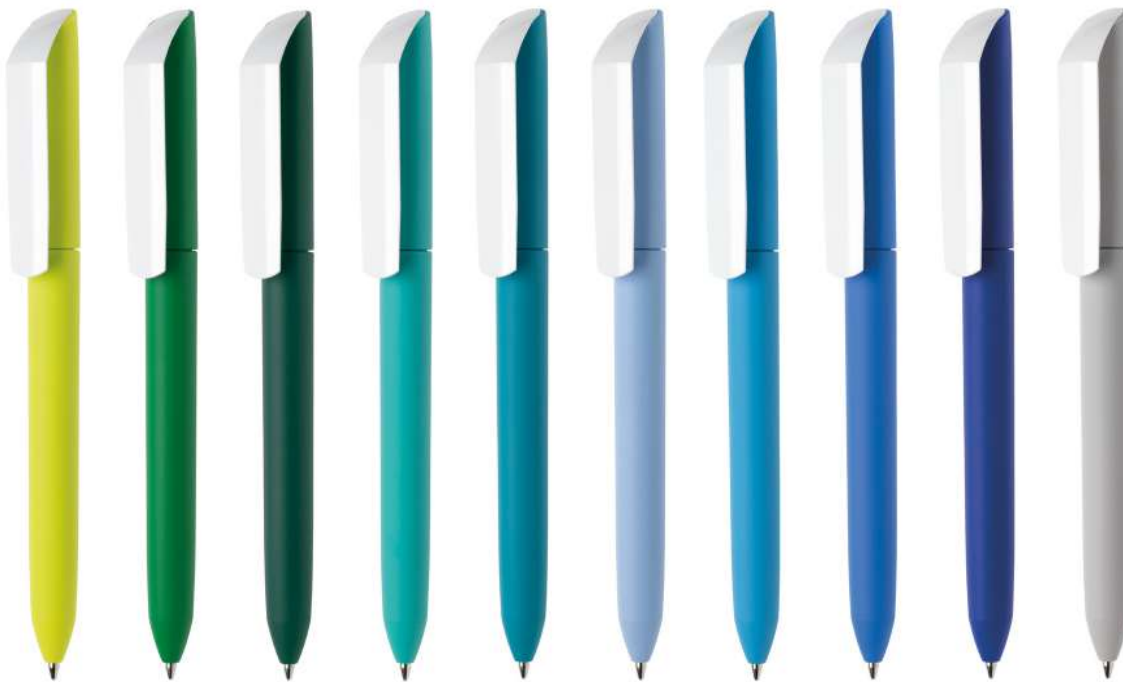

79

09

75

26

27

64

77

12

22

05

04 black / pad printing 40 x 9 mm  
04 nero / tampografia 40 x 9 mm



Solid colour barrel and cap with rubber finish, transparent colour clip with glossy finish

Even the rubberised barrel can be pad or silk-screen printed.



39

52

53

45

59

41

31

55

37

38 brown / pad printing 40 x 9 mm  
38 marrone / tampografia 40 x 9 mm



Fusto e cappuccio in colore coprente gommato, clip in colore trasparente lucido

Anche il fusto è stampabile con tampografia o serigrafia.

49 green / pad printing 50 x 9 mm  
49 verde / tampografia 50 x 9 mm



78



47



34



67



44



30

50 dark grey / pad printing 40 x 9 mm  
50 grigio scuro / tampografia 40 x 9 mm



Solid fluo colour barrel and cap with rubber finish, solid fluo colour clip with glossy finish

*Fusto e cappuccio in colore fluo coprente gommato, clip in colore fluo coprente lucido*

FLUO



02



17



14



08

56 fuchsia / pad printing 40 x 9 mm  
56 fuchsia / tampografia 40 x 9 mm

F2P | GOM KF

Solid black colour barrel and cap with rubber finish, solid fluo colour clip with glossy finish

*Fusto e cappuccio in colore nero coprente gommato, clip in colore fluo coprente lucido*



02 yellow / pad printing 40 x 9 mm  
02 giallo / tampografia 40 x 9 mm

**FLUO**



17



56



08

14 coral red / pad printing 40 x 9 mm  
14 rosso corallo / tampografia 40 x 9 mm

Solid fluo colour barrel and cap with rubber finish, transparent fluo colour clip with glossy finish

Minimal profile and compact volumes.

FLUO



20



24

33 orange /  
pad printing 40 x 9 mm  
33 arancio /  
tampografia 40 x 9 mm

*Fusto e cappuccio in colore fluo  
coprente gommato, clip in colore fluo  
trasparente lucido*

Profilo minimal  
e volumi compatti.

FLUO



46

48 green / pad printing 40 x 9 mm  
48 verde / tampografia 40 x 9 mm





F2P | MATT CB RE

PLASTIC POST-CONSUMER RECYCLED

Post-consumer recycled plastic  
Solid colour barrel and cap, solid white  
colour clip, matt finish

Made of WEEE  
(Waste of Electrical  
and Electronic  
Equipment)  
recycled plastic.



10



76

87 mud / pad printing 40 x 9 mm  
tampografia 40 x 9 mm



Extra customisation is available to  
tell the story of this pen's origin.  
Info at p. 276

*Disponibile una personalizzazione  
extra per raccontare l'origine di  
questa penna. Info a pag. 276*



*Plastica riciclata post-consumo  
Fusto e cappuccio in colore coprente,  
clip in colore bianco coprente,  
finitura satinata*

Realizzata in  
plastica riciclata  
da RAEE (Rifiuti  
di Apparecchiature  
Elettriche ed  
Elettroniche).



19



21



58



07 onyx / pad printing 40 x 9 mm  
tampografia 40 x 9 mm

**Download  
Post-consumer  
Recycled  
Collection  
Catalogue**

Scarica il catalogo  
Post-consumer  
Recycled  
Collection





F2P | MATT RE

RECYCLED PLASTIC POST-CONSUMER

Post-consumer recycled plastic  
Solid colours with matt finish

Design embraces sustainability.



06



76



87

10 cloud / pad printing 40 x 9 mm  
tampografia 40 x 9 mm



Universal single pen case in  
Fedrigoni recycled paper Gesso.  
Info at p. 281

Astuccio universale  
per penna singola  
in cartoncino riciclato Fedrigoni  
Gesso.  
Info pag. 281



*Plastica riciclata post-consumo  
Colori coprenti con finitura satinata*

Il design  
abbraccia  
la sostenibilità.



19



21



58



07

**Download  
Post-consumer  
Recycled  
Collection  
Catalogue**

Scarica il catalogo  
Post-consumer  
Recycled  
Collection



F2P | C AB

Antibacterial plastic, solid white colour with glossy finish

Take care of yourself, even when you write.



01



solid / coprenti

01

white  
bianco

*Plastica antibatterica, colore bianco coprente con finitura lucida*

Anche quando scrivi, prenditi cura di te.



Universal reclosable single pen case in Fedrigoni recycled paper Gesso. Info at p. 288

*Astuccio universale richiudibile per penna singola in cartoncino riciclato Fedrigoni Gesso. Info pag. 288*

**Download  
Antibacterial  
Pens  
catalogue**

Scarica il  
Catalogo  
Antibacterial  
Pens



Technical information  
*Informazioni tecniche*

# Flow Pure

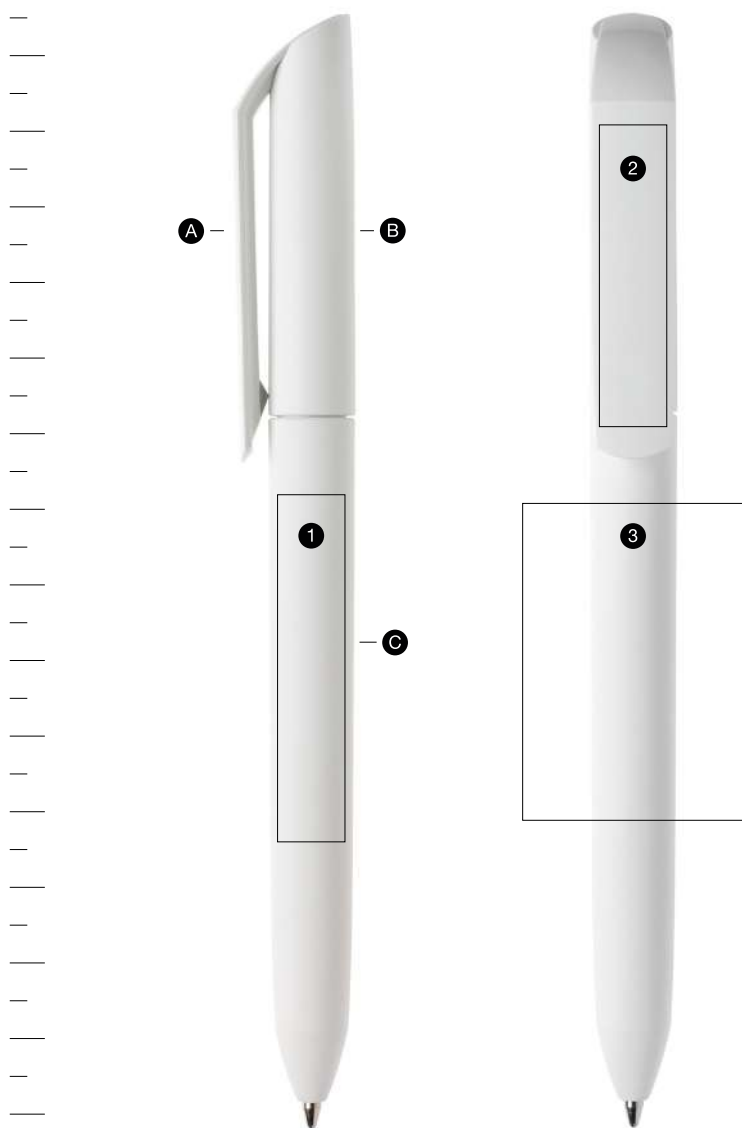

ø 10,2 mm  
h 141 mm



POST-CONSUMER  
RECYCLED PLASTIC

Zink is available  
in post-consumer recycled plastic/  
*La penna Zink è disponibile  
in plastica riciclata post-consumo*

ANTIBACTERIAL  
PLASTIC

Zink is available in white  
antibacterial plastic/  
*La penna Zink è disponibile  
in plastica antibatterica bianca*

## Components / Componenti

- Ⓐ Clip
- Ⓑ Cap / cappuccio
- Ⓒ Barrel / fusto

## Print area / Area stampabile

- ① pad printing / tampografia  
50 x 9 mm
- ② pad printing / tampografia  
40 x 9 mm
- ③ screen printing / serigrafia  
45 x 30 mm

## Features / Caratteristiche

twist-action / meccanismo a rotazione

made of non-toxic highly resistant ABS  
plastic / realizzata in plastica ABS,  
atossica e ad alta resistenza

Jumbo refill, blue and black ink / refill  
Jumbo, inchiostro blu e nero

available in glossy, matt or rubberised  
finish / disponibile con superfici lucide,  
satinare o gommate

 F2P – POST-CONSUMER RECYCLED  
PLASTIC / PLASTICA RICICLATA  
POST-CONSUMO

Small imperfections and slight colour variations  
are to be considered intrinsic features of  
the recycled material deriving from the post-  
consumer sector. / Piccole imperfezioni e lievi  
variazioni cromatiche sono da considerarsi  
caratteristiche intrinseche del materiale riciclato  
derivante dal post-consumo.

**Fast Dry Gel** blue and black ink available  
on request /  
*Refill Gel Fast Dry blu e nero disponibile  
su richiesta*

# Flow

---



Feel the change.  
*Senti il cambiamento.*

---

Evolution of shape,  
with and without texturing.

*L'evoluzione della forma,  
con e senza texture.*



Technical information at p. 127  
*Informazioni tecniche a pag. 127*

---

F1 | MATT AL

Solid colours with matt finish,  
aluminium painted finish tip

Matt colours  
and aluminium  
colour tip: satin  
style elegance.



01

70

03

18

15

74

60

61

71

25

73

Colori coprenti con finitura  
satinata, punta verniciata  
in colore alluminio

Colori matt  
e punta color  
alluminio:  
eleganza in  
versione satinata.

79 lime / pad printing 40 x 9 mm  
79 lime / tampografia 40 x 9 mm



09      75      26      27      64

77 cyan / pad printing 40 x 9 mm  
77 ciano / tampografia 40 x 9 mm



12      22      05      04

F1

C CR

Solid colours with glossy finish,  
chromed tip



70

03

18

15

74

60

61

71

25

73

01 white / pad printing 40 x 9 mm  
01 bianco / tampografia 40 x 9 mm

Colori coprenti con finitura lucida,  
punta cromata



79

09

75

26

27

64



12

22

05

04

77 cyan / pad printing 40 x 9 mm  
77 ciano / tampografia 40 x 9 mm

F1T | GOM C CR

Solid colour barrel with rubber finish, solid colour clip with glossy finish, textured solid colour cap with matt finish, chromed tip

Distinctive feature: textured cap.



01

70

03

15

74

60

61

71

25

73

18 orange / pad printing 40 x 9 mm  
18 arancio / tampografia 40 x 9 mm

*Fusto in colore coprente gommato,  
clip in colore coprente lucido,  
cappuccio texturizzato in colore  
coprente con finitura satinata,  
punta cromata*

Elemento  
distintivo:  
cappuccio  
arricchito da  
una texture.



79

09

75

26

27

64

77

12

22

05

04 black / pad printing 40 x 9 mm  
04 nero / tampografia 40 x 9 mm



F1T | GOM CB CR

Solid colour barrel with rubber finish, solid glossy white colour clip, textured solid colour cap with matt finish, chromed tip

Textured with small hexagonal cells that recall a honeycomb: a dynamic design of visual and tactile elegance.



03

18

15

74

60

61

71

25

79

73 brown / pad printing 40 x 9 mm  
73 marrone / tampografia 40 x 9 mm

Fusto in colore coprente gommato, clip in colore bianco lucido, cappuccio texturizzato in colore coprente con finitura satinata, punta cromata

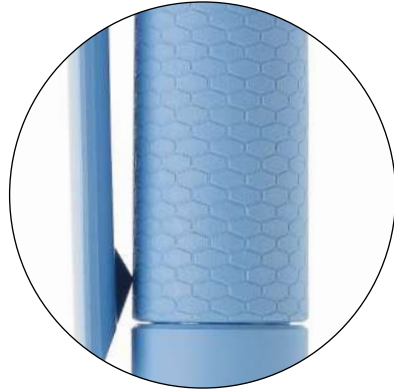

Texture costituita da piccole celle esagonali che ricordano un nido d'ape: un design dinamico che dona eleganza visiva e tattile.



09

75

27

64

77

12

22

04

26 aquamarine / pad printing 40 x 9 mm  
26 acquamarina / tampografia 40 x 9 mm

05 grey / pad printing 40 x 9 mm  
05 grigio / tampografia 40 x 9 mm

F1T | GOM 30 CR

Solid colour barrel with rubber finish, transparent glossy colour clip, textured solid colour cap with matt finish, chromed tip



39



52



53



45



59 pink / pad printing 40 x 9 mm  
59 rosa / tampografia 40 x 9 mm



41



31



55



37

*Fusto in colore coprente gommato,  
clip in colore trasparente lucido,  
cappuccio texturizzato in colore  
coprente con finitura satinata,  
punta cromata*

30 light grey / pad printing 40 x 9 mm  
30 grigio chiaro / tampografia 40 x 9 mm



38



78



49



47



67



44



50

34 pastel blue / pad printing 40 x 9 mm  
34 azzurro pastello / tampografia 40 x 9 mm

Technical information  
*Informazioni tecniche*

# Flow

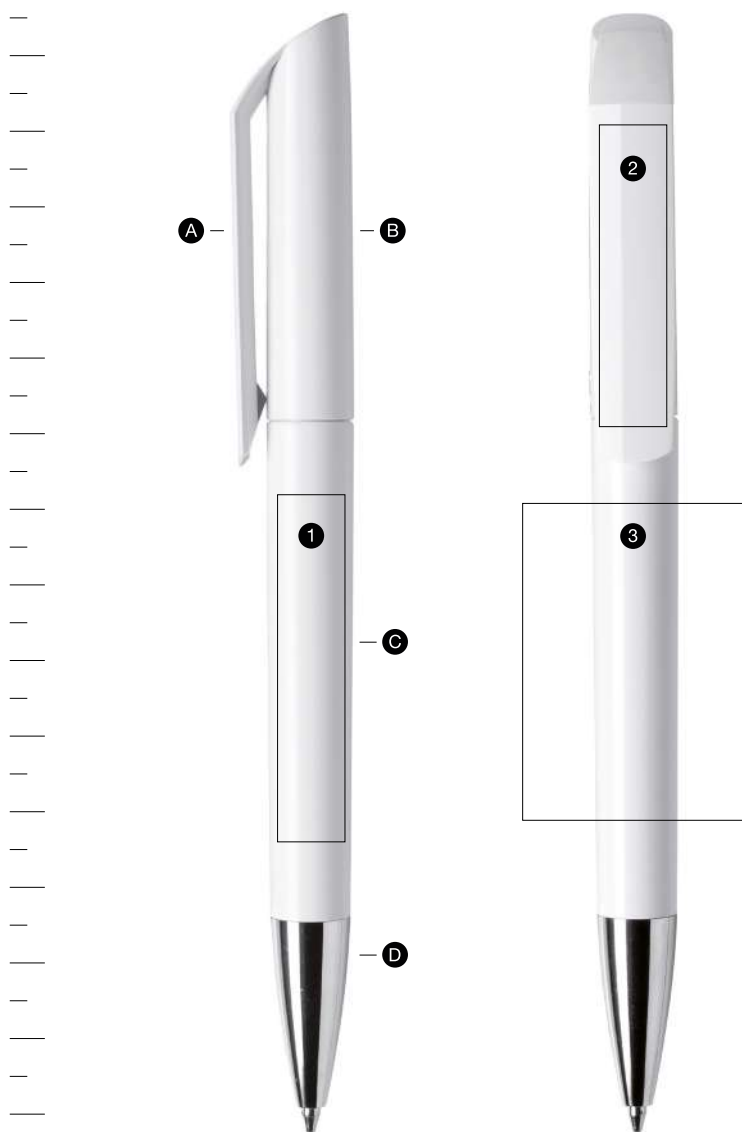

ø 11,4 mm  
h 142 mm



The entire Maxema collection is available  
in post-consumer recycled plastic on request /  
*Tutta la collezione Maxema è realizzabile  
in plastica riciclata post-consumo su richiesta*

## Components / Componenti

- Ⓐ Clip
- Ⓑ Cap / cappuccio
- Ⓒ Barrel / fusto
- Ⓓ Tip / punta

## Print area / Area stampabile

- ① pad printing / tampografia  
46 x 9 mm
- ② pad printing / tampografia  
40 x 9 mm
- ③ screen printing / serigrafia  
42 x 30 mm

## Features / Caratteristiche

twist-action / meccanismo a rotazione

made of non-toxic highly resistant ABS  
plastic / realizzata in plastica ABS,  
atossica e ad alta resistenza

galvanic process used to chrome tip /  
la cromatura della punta è ottenuta  
con trattamento galvanico

Jumbo refill, blue and black ink /  
refill Jumbo, inchiostro blu e nero

available in glossy, matt or rubberised  
finish / disponibile con superfici lucide,  
satinato o gommato

in the Texture version, the entire matt  
cap features a honeycomb design /  
nella versione Texture il cappuccio  
satinato è percorso interamente da una  
trama a nido d'ape

**Fast Dry Gel** blue and black ink available  
on request /  
Refill Gel Fast Dry blu e nero disponibile  
su richiesta

# Dot

---



Different from the rest, full stop.  
*Diversa da tutte, punto.*

---

A pen that reveals  
its originality in its details.

*È nei dettagli che rivela  
la sua originalità.*



Also available in post-consumer recycled plastic /  
*Disponibile anche in plastica riciclata post-consumo*



Also available in antibacterial plastic /  
*Disponibile anche in plastica antibatterica*

---

Technical information at p. 165  
*Informazioni tecniche a pag. 165*

---

D1 | MATT B

Solid white colour barrel, clip and push-button with matt finish, solid glossy colour little sphere

The matt finish enhances the design and offers new tactile sensations.



01

03 yellow / pad printing 40 x 9 mm  
03 giallo / tampografia 40 x 9 mm

The touch of colour stands out against the pure white.

*Fusto, clip e tappino in colore bianco coprente con finitura satinata, piccola sfera in colore coprente lucido*

La finitura satinata esalta il design e offre nuove sensazioni tattili.



18



15



74



60



61



71



25



73



79



09



75



26



27



64



77



12



22



05



04

Il punto di colore spicca nella nitidezza del bianco.

D1 | MATT CB

Solid colour barrel with matt finish, solid matt white clip and push-button, solid glossy colour little sphere



03

18

15

74

61

71

25

73

60 pink / pad printing 40 x 9 mm  
60 rosa / tampografia 40 x 9 mm

Fusto in colore coprente con finitura satinata, clip e tappino in colore bianco coprente satinato, piccola sfera in colore coprente lucido



79

09

75

26

27

64

77

22

05

04

12 light blue / pad printing 40 x 9 mm  
12 azzurro / tampografia 40 x 9 mm

D1 | MATT

Solid colours with matt finish, solid glossy colour little sphere

Attractive and refined: the integral matt finish.



70

03

18

15

74

60

61

25

72

73

71 light violet / pad printing 40 x 9 mm  
71 viola chiaro / tampografia 40 x 9 mm

---

*Colori coprenti con finitura  
satinata, piccola sfera in colore  
coprente lucido*

Attrante  
e raffinata:  
è la finitura  
satinata integrale.

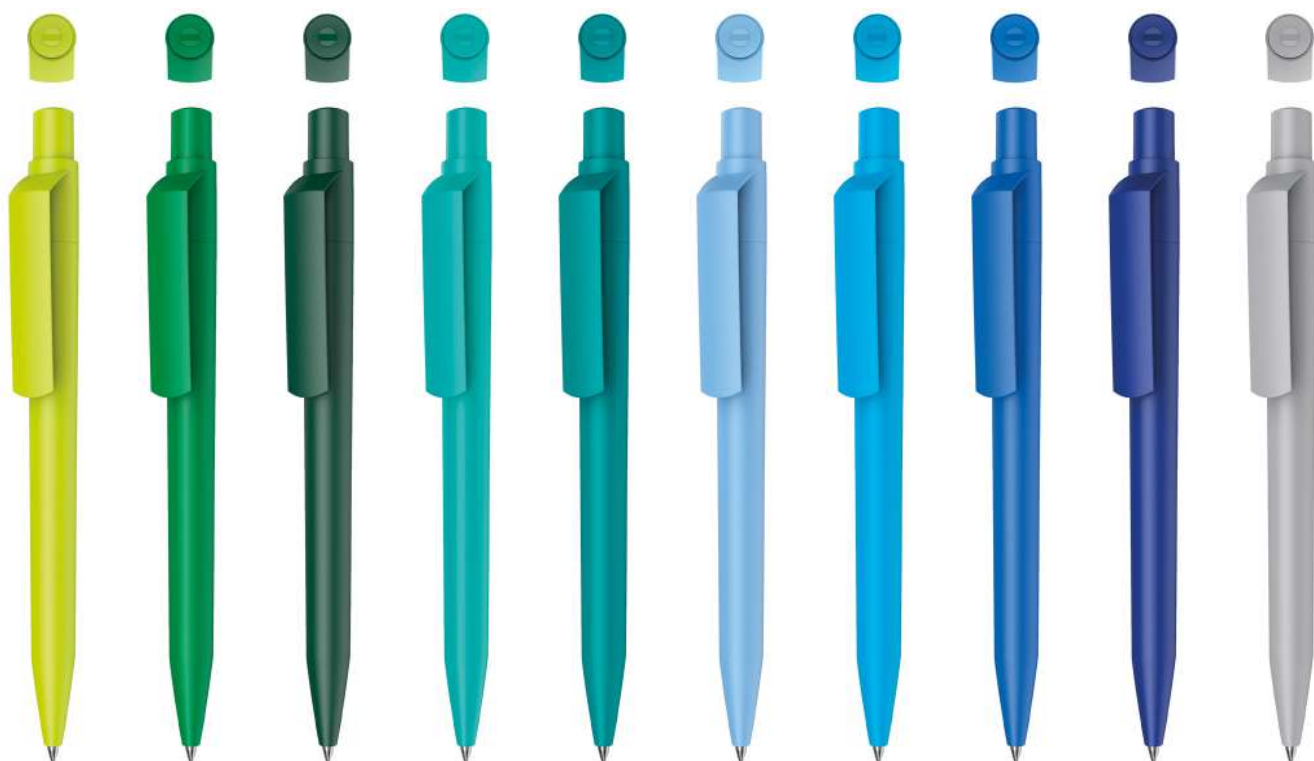

79

09

75

26

27

64

77

12

22

05

D1 | MATT K

Solid black colour barrel, clip and push-button with matt finish, solid glossy colour little sphere

Purity of lines and matt finish:  
simply elegant.



01

70 cream / pad printing 40 x 9 mm  
70 crema / tampografia 40 x 9 mm

Minimal black  
is combined with  
a discreet touch  
of colour.

Fusto, clip e tappino in colore nero coprente con finitura satinata, piccola sfera in colore coprente lucido

Purezza di linee e finitura matt: semplicemente elegante.



03



18



15



74



60



61



71



25



72



73



79



09



75



26



27



77



12



22



05



04

Il nero minimal è abbinato a una piccola e discreta nota di colore.

Solid fluo colours with matt finish,  
solid glossy fluo colour little sphere

A more profound  
chromatic impact  
thanks to the fluo  
colours.

**FLUO**



02



17



56



08

14 coral red / pad printing 40 x 9 mm  
14 rosso corallo / tampografia 40 x 9 mm

*Colori fluo coprenti con finitura  
satinata, piccola sfera in colore fluo  
coprente lucido*

Impatto cromatico  
più incisivo  
grazie ai colori  
fluo.

**FLUO**

D1

B CR

Solid white colour barrel and clip with glossy finish, solid glossy colour little sphere, chromed push-button



01



03 yellow / pad printing 40 x 9 mm  
03 giallo / tampografia 40 x 9 mm

A white surface is the creative foundation par excellence: freedom of expression and top colour rendering.

Total white: basic and elegant thanks to its refined colour detail.

*Fusto e clip in colore bianco coprente con finitura lucida, piccola sfera in colore coprente lucido, tappino cromato*



18



15



74



60



61



71



25



73



79



09



75



27



64



77



12



22



05



04

La superficie bianca è la base creativa per eccellenza: libertà di espressione e massima resa cromatica.

Total white: essenziale ed elegante grazie al raffinato dettaglio di colore.

D1 | CB CR

Solid colour barrel and little sphere with glossy finish, solid glossy white colour clip, chromed push-button



03

18



74

60

61

71

25

73

79

15 red / pad printing 40 x 9 mm  
15 rosso / tampografia 40 x 9 mm

*Fusto e piccola sfera in colore  
coprente lucido, clip in colore bianco  
coprente lucido, tappino cromato*



09

75

27

64

77

12

22

05



04 black /  
pad printing  
40 x 9 mm  
04 nero /  
tampografia  
40 x 9 mm

D1

C CR

Solid colours with glossy finish,  
chromed push-button

74 burgundy / pad printing 40 x 9 mm  
74 bordeaux / tampografia 40 x 9 mm



70

03

15

60

61

71

25

18 orange /  
pad printing  
40 x 9 mm  
18 arancio /  
tampografia  
40 x 9 mm



Colori coprenti con finitura lucida,  
tappino cromato

64 pastel blue / pad printing 40 x 9 mm  
64 azzurro pastello / tampografia 40 x 9 mm



73

79

09

75

27



77

12

22

05



04 black /  
pad printing  
40 x 9 mm  
04 nero /  
tampografia  
40 x 9 mm

D1

30 CR

Transparent colours with glossy finish, solid glossy colour little sphere, chromed push-button



39



53



45



41



55



37



38

52 yellow / pad printing 40 x 9 mm  
52 giallo / tampografia 40 x 9 mm

Colori trasparenti con finitura lucida, piccola sfera  
in colore coprente lucido, tappino cromato



49

47

67

44

50

78 lime /  
pad printing  
40 x 9 mm  
78 lime /  
tampografia  
40 x 9 mm

D1

GOM K

Solid black colour barrel with rubber finish, solid black colour clip and push-button with glossy finish, solid glossy colour little sphere

The elegance of black combines with a soft touch finish for a high-impact result.



01



70 cream / pad printing 40 x 9 mm  
70 crema / tampografia 40 x 9 mm

Total black with a note of colour.

*Fusto in colore nero coprente gommato, clip e tappino in colore nero coprente lucido, piccola sfera in colore coprente lucido*

L'eleganza del nero si combina con la finitura soft touch per un risultato di grande impatto.



03



18



15



74



60



61



71



25



72



73



79



09



75



26



27



77



12



22



05



04

Total black  
con nota di colore.

D1

GOM CB CR

Solid colour barrel with rubber finish, solid glossy white colour clip, solid glossy colour little sphere, chromed push-button



01

03

stackoverflow

15

74

60

61

71

73

18 orange /  
pad printing  
40 x 9 mm  
18 arancio /  
tampografia  
40 x 9 mm

25 dark violet /  
pad printing  
40 x 9 mm  
25 viola scuro /  
tampografia  
40 x 9 mm

64 pastel blue / pad printing 40 x 9 mm  
64 azzurro pastello / tampografia 40 x 9 mm



*Fusto in colore coprente gommato,  
clip in colore bianco coprente lucido,  
piccola sfera in colore coprente  
lucido, tappino cromato*



79

09

75

26

27



77

12

22



04

05 grey /  
pad printing  
40 x 9 mm  
05 grigio /  
tampografia  
40 x 9 mm

D1 | GOM C CR

Solid colour barrel with rubber finish, solid colour clip and little sphere with glossy finish, chromed push-button

71 light violet / pad printing 40 x 9 mm  
71 viola chiaro / tampografia 40 x 9 mm



18

15

74

60

61



25

72

73

03 yellow / pad printing 40 x 9 mm  
03 giallo / tampografia 40 x 9 mm

*Fusto in colore coprente gommato, clip e piccola sfera in colore coprente con finitura lucida, tappino cromato*

22 blue / pad printing 40 x 9 mm  
22 blu / tampografia 40 x 9 mm



79

09

75

27

64

77

12

05

04

D1 | GOM 30 CR

Solid colour barrel with rubber finish, transparent colour clip with glossy finish, solid glossy colour little sphere, chromed push-button



39

52

53

45

59

41

31

55

37

38 brown / pad printing 40 x 9 mm  
38 marrone / tampografia 40 x 9 mm

*Fusto in colore coprente gommato, clip in colore trasparente con finitura lucida, piccola sfera in colore coprente lucido, tappino cromato*



78

49

47

34

67

44

30

50 dark grey / pad printing 40 x 9 mm  
50 grigio scuro / tampografia 40 x 9 mm

D1 | C GOLD

Solid colours with glossy finish,  
gilded push-button

*Colori coprenti con finitura lucida,  
tappino dorato*



01 white / pad printing 40 x 9 mm  
01 bianco / tampografia 40 x 9 mm



04

D1 | GOM KF CR

Solid black colour barrel with rubber finish, solid fluo colour clip and little sphere with glossy finish, chromed push-button

*Fusto in colore nero coprente gommato, clip e piccola sfera in colore fluo coprente lucido, tappino cromato*

FLUO



02

17 orange /  
pad printing  
40 x 9 mm  
17 arancio /  
tampografia  
40 x 9 mm



56

14 coral red / pad printing 40 x 9 mm  
14 rosso corallo / tampografia 40 x 9 mm



08



## D1 | MATT CB RE

PLASTIC POST-CONSUMER RECYCLED

Post-consumer recycled plastic  
Solid colour barrel with matt finish,  
solid matt white clip and push-button,  
solid glossy white little sphere

Made of WEEE  
(Waste of Electrical  
and Electronic  
Equipment)  
recycled plastic.



10



76



87

Extra customisation is available to  
tell the story of this pen's origin.  
Info at p. 277

*Disponibile una personalizzazione  
extra per raccontare l'origine di  
questa penna. Info a pag. 277*



*Plastica riciclata post-consumo  
Fusto in colore coprente con finitura  
satinata, clip e tappino in colore bianco  
coprente satinato, piccola sfera in  
colore bianco coprente lucido*

Realizzata in  
plastica riciclata  
da RAEE (Rifiuti  
di Apparecchiature  
Elettriche ed  
Elettroniche).



19



58



07

21 abyss / pad printing 40 x 9 mm  
tampografia 40 x 9 mm

**Download  
Post-consumer  
Recycled  
Collection  
Catalogue**

Scarica il catalogo  
Post-consumer  
Recycled  
Collection





D1 | MATT RE



Post-consumer recycled plastic  
Solid colours with matt finish,  
solid glossy colour little sphere

The beauty  
of sustainability:  
8 colour  
shades inspired  
by nature.



10



76



87

06 ice / pad printing 40 x 9 mm  
tampografia 40 x 9 mm



Universal single pen case  
in Fedrigoni recycled paper  
Ardesia. Info at p. 280

Astuccio universale  
per penna singola  
in cartoncino riciclato  
Fedrigoni Ardesia.  
Info pag. 280



*Plastica riciclata post-consumo  
Colori coprenti con finitura satinata,  
piccola sfera in colore coprente lucido*

La bellezza  
della sostenibilità:  
8 sfumature  
di colore ispirate  
alla natura.



19



21



58



07

**Download  
Post-consumer  
Recycled  
Collection  
Catalogue**

Scarica il catalogo  
Post-consumer  
Recycled  
Collection



D1

MATT CB AB

Antibacterial plastic, solid colour barrel with matt finish, solid glossy white clip, push-button and little sphere

No bacteria,  
that's the message

15 red / pad printing 40 x 9 mm  
15 rosso / tampografia 40 x 9 mm



03



18



74



60



61



71



25 dark violet / pad printing 40 x 9 mm  
25 viola scuro / tampografia 40 x 9 mm

*Plastica antibatterica, fusto in colore  
coprente con finitura satinata, clip,  
tappino e piccola sfera  
in colore bianco coprente lucido*

Niente batteri,  
è questo il  
messaggio

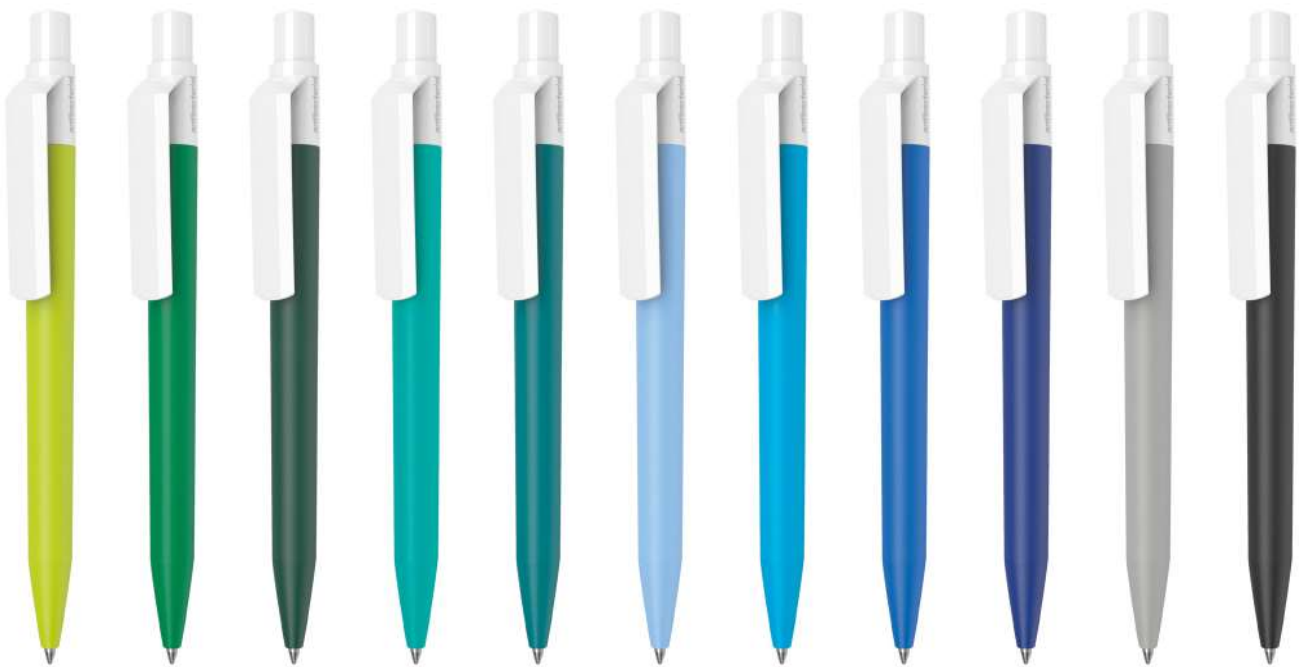

79

09

75

26

27

64

77

12

22

05

04

**Download  
Antibacterial  
Pens  
catalogue**

Scarica il  
Catalogo  
Antibacterial  
Pens



Technical information  
*Informazioni tecniche*

# Dot

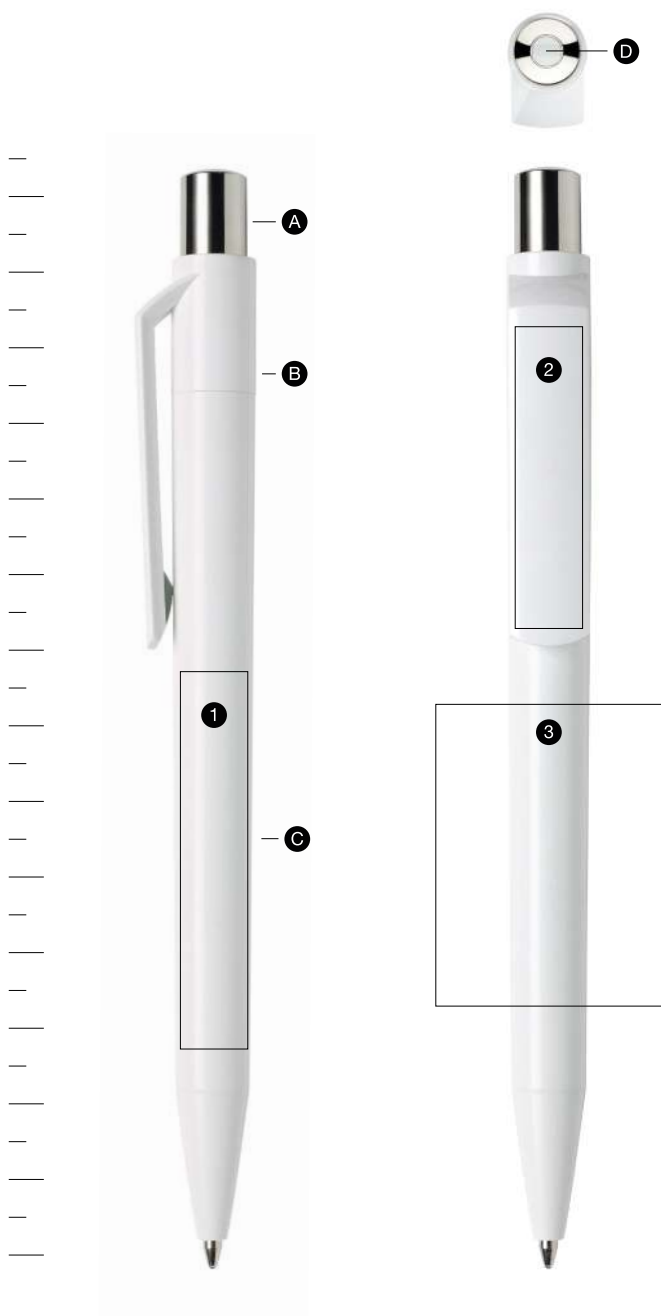

ø 10,5 mm  
h 141 mm



Zink is available  
in post-consumer recycled plastic/  
*La penna Zink è disponibile  
in plastica riciclata post-consumo*

ANTIBACTERIAL  
PLASTIC

Zink is available in white  
antibacterial plastic/  
*La penna Zink è disponibile  
in plastica antibatterica bianca*

## Components / Componenti

- A** Push-button / tappino
- B** Clip
- C** Barrel / fusto
- D** Little sphere / piccola sfera

## Print area / Area stampabile

- 1** pad printing / tampografia  
50 x 9 mm
- 2** pad printing / tampografia  
40 x 9 mm
- 3** screen printing / serigrafia  
40 x 30 mm

## Features / Caratteristiche

retractable with return spring /  
meccanismo a scatto, con molla di ritorno

made of non-toxic, highly resistant  
ABS plastic / realizzata in plastica ABS  
atossica e ad alta resistenza

galvanic process used to chrome  
and gild ABS push-button / la cromatura e  
la doratura del tappino sono ottenute con  
trattamento galvanico

Jumbo refill, blue and black ink / refill Jumbo,  
inchiostro blu e nero

available in glossy, matt  
or rubberised finish / disponibile con superfi-  
ci lucide, satinare o gommate

 D1 – POST-CONSUMER RECYCLED PLASTIC  
PLASTICA RICICLATA POST-CONSUMO

Small imperfections and slight colour variations  
are to be considered intrinsic features of  
the recycled material deriving from the post-consumer  
sector. / Piccole imperfezioni e lievi variazioni cromatiche  
sono da considerarsi caratteristiche intrinseche del  
materiale riciclato derivante dal post-consumo.

**Fast Dry Gel** blue and black ink available  
on request /  
*Refill Gel Fast Dry blu e nero disponibile  
su richiesta*

# Zink

---



Solid geometries.  
*Solide geometrie.*

---

A pen with a  
clean-cut profile  
and strong personality.

*Una penna  
dal profilo tagliente  
e dal carattere deciso.*

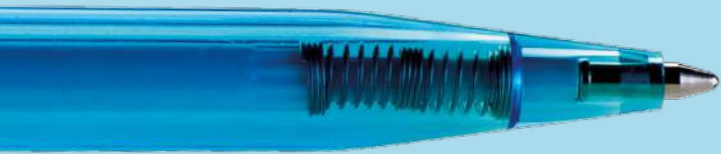

Also available in post-consumer recycled plastic /  
*Disponibile anche in plastica riciclata post-consumo*



Also available in white antibacterial plastic /  
*Disponibile anche in plastica antibatterica bianca*

---

Technical information at p. 183  
*Informazioni tecniche a pag. 183*

---

Solid colours barrel, solid white colour cap, glossy finishes

More suitability for multi-colour printing with white clip.



70

03

18

15

74

61

71

25

73

60 pink / pad printing 43 x 9 mm  
60 rosa / tampografia 43 x 9 mm

*Fusto in colori coprenti,  
cappuccio in colore bianco coprente,  
finiture lucide*

Maggiore versatilità  
per la stampa  
a più colori con  
la clip bianca.



79

09

75

26

27

64

77

22

05

04

12 light blue / pad printing 43 x 9 mm  
12 azzurro / tampografia 43 x 9 mm

Solid colours with glossy finish

Solid, sturdy architecture for a profile of geometric precision.



01

70

03



15

74

60

61

25

73

18 orange / pad printing 43 x 9 mm  
18 arancio / tampografia 43 x 9 mm

Colori coprenti con finitura lucida

Architettura  
corposa e robusta  
per un profilo dal  
rigore geometrico.

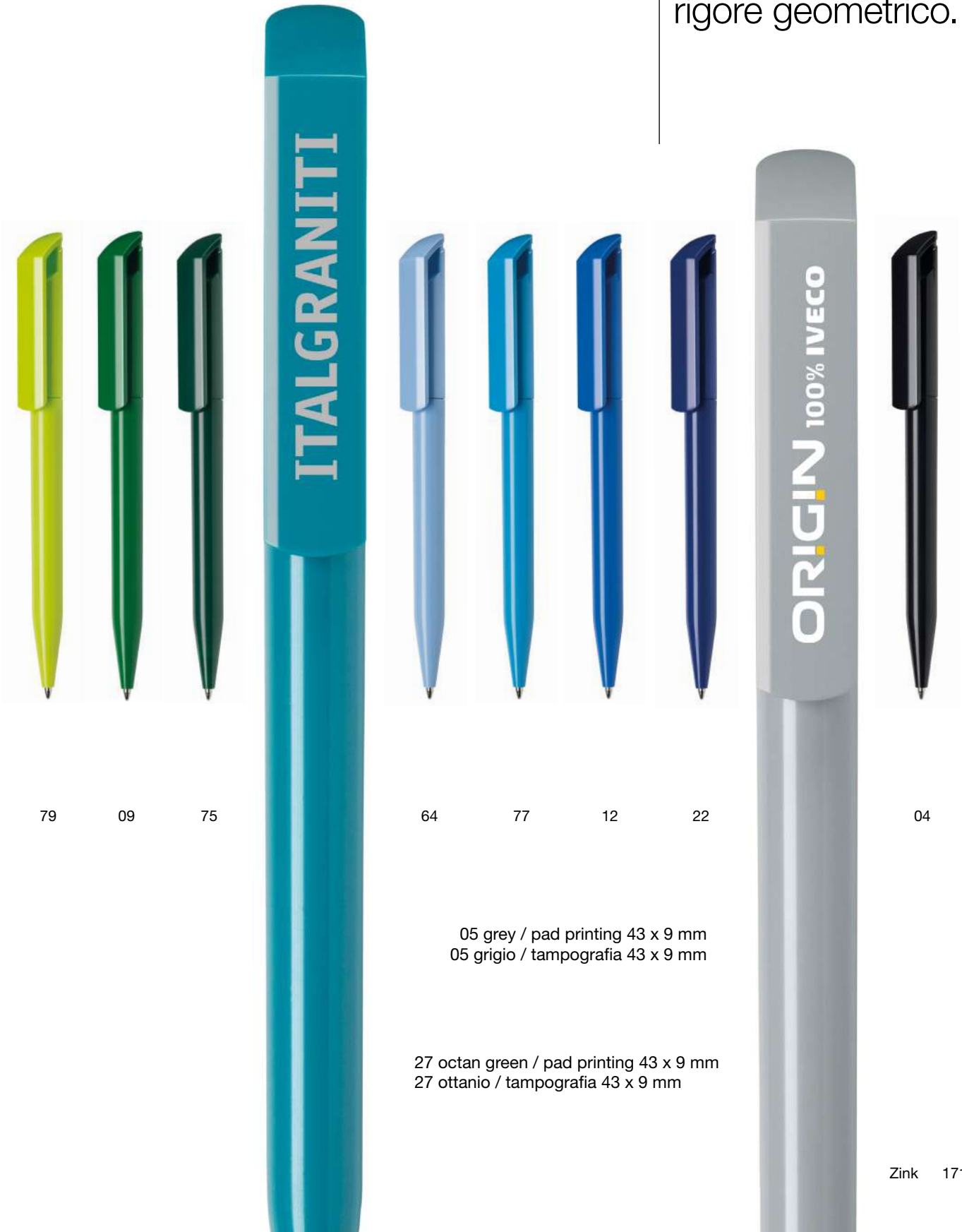

Transparent colours with glossy finish

Its sturdy structure  
is offset by the  
slim, streamlined  
barrel.



39

52

53

45

59

41

51

31

55



37 amber / pad printing 43 x 9 mm  
37 ambra / tampografia 43 x 9 mm

Colori trasparenti con finitura lucida

Il fusto slanciato  
bilancia la solida  
struttura.

67 cyan / pad printing 43 x 9 mm  
67 ciano / tampografia 43 x 9 mm



38

78

49

47



44

30

50

Fluo colours,  
intense and  
vibrant shades.

FLUO



02

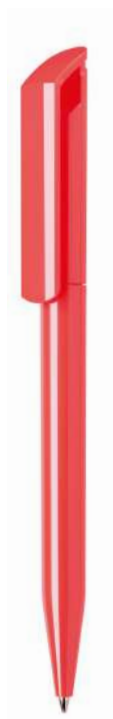

14



56

17 orange / pad printing 43 x 9 mm  
17 arancio / tampografia 43 x 9 mm

*Colori fluo coprenti  
con finitura lucida*

Colori fluo,  
tonalità intense  
e vibranti.

**FLUO**



08 green / pad printing 43 x 9 mm  
08 verde / tampografia 43 x 9 mm



Z1 | CB RE

RECYCLED PLASTIC POST-CONSUMER

Post-consumer recycled plastic  
Solid colours barrel, solid white  
colour cap, glossy finishes

Made of WEEE  
(Waste of Electrical  
and Electronic  
Equipment)  
recycled plastic.



10



76



87

Extra customisation is available to  
tell the story of this pen's origin.  
Info at p. 276

*Disponibile una personalizzazione  
extra per raccontare l'origine di  
questa penna. Info a pag. 276*



*Plastica riciclata post-consumo  
Fusto in colori coprenti, cappuccio in  
colore bianco coprente, finiture lucide*

Realizzata in  
plastica riciclata  
da RAEE (Rifiuti  
di Apparecchiature  
Elettriche ed  
Elettroniche).



19



21 abyss / pad printing 43 x 9 mm  
tampografia 43 x 9 mm



58



07

**Download  
Post-consumer  
Recycled  
Collection  
Catalogue**

Scarica il catalogo  
Post-consumer  
Recycled  
Collection





Z1 | C RE

RECYCLED POST-CONSUMER PLASTIC

Post-consumer recycled plastic  
Solid colours with glossy finish

Elegance and environmental friendliness: uncompromisingly together.



06



76



87

10 cloud / pad printing 43 x 9 mm  
tampografia 43 x 9 mm



Universal reclosable single pen case in Fedrigoni recycled paper Ardesia. Info at p. 288

*Astuccio universale richiudibile per penna singola in cartoncino riciclato Fedrigoni Ardesia. Info pag. 288*



*Plastica riciclata post-consumo  
Colori coprenti con finitura lucida*

Eleganza e  
attenzione per  
l'ambiente:  
insieme senza  
compromessi.



19



21



58

07 onyx / pad printing 43 x 9 mm  
tampografia 43 x 9 mm



**Download  
Post-consumer  
Recycled  
Collection  
Catalogue**

Scarica il catalogo  
Post-consumer  
Recycled  
Collection



Z1 | C AB

Antibacterial plastic, solid white colour with glossy finish

Write without limits and bacteria.



01



solid / coprenti

01

white  
bianco

*Plastica antibatterica, colore bianco  
coprente con finitura lucida*

Scrivi senza limiti  
e batteri.



Universal reclosable single pen case  
in Fedrigoni recycled paper Gesso.  
Info at p. 288

*Astuccio universale richiudibile per  
penna singola in cartoncino riciclato  
Fedrigoni Gesso.  
Info pag. 288*

**Download  
Antibacterial  
Pens  
catalogue**

Scarica il  
Catalogo  
Antibacterial  
Pens



Technical information  
*Informazioni tecniche*

# Zink

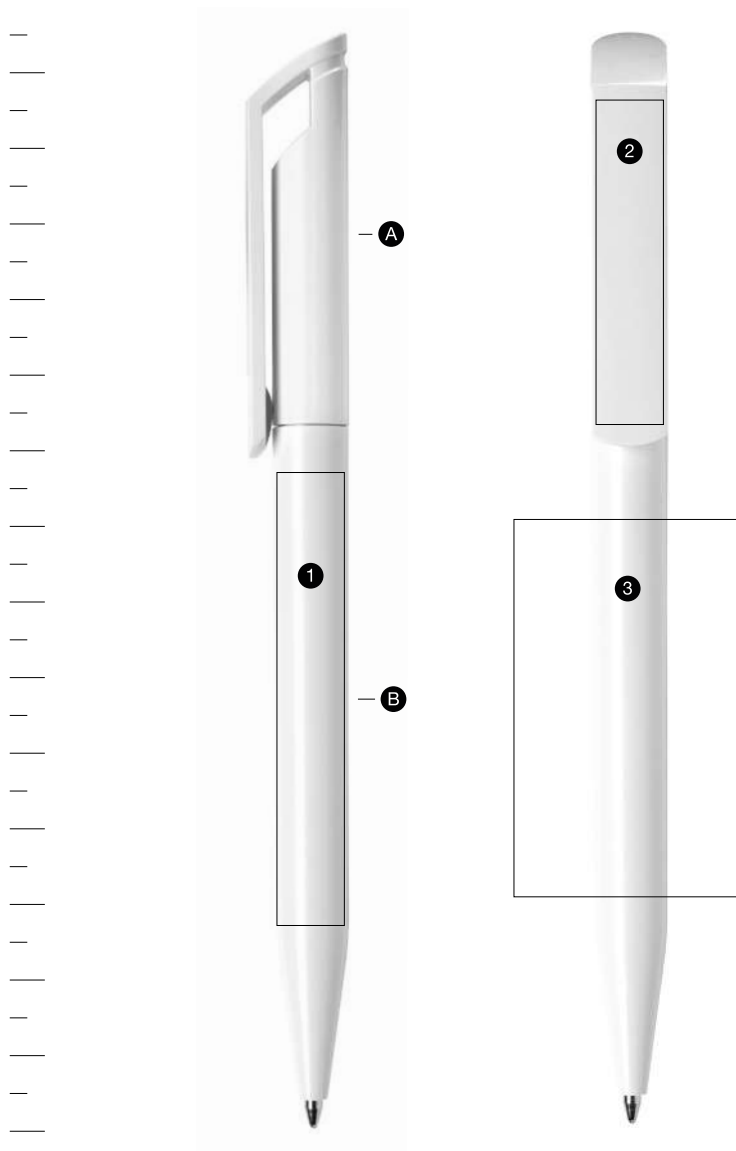

ø 10 mm  
h 147 mm



Zink is available  
in post-consumer recycled plastic/  
*La penna Zink è disponibile  
in plastica riciclata post-consumo*



Zink is available in white  
antibacterial plastic/  
*La penna Zink è disponibile  
in plastica antibatterica bianca*

## Components / Componenti

- Ⓐ Cap / cappuccio
- Ⓑ Barrel / fusto

## Print area / Area stampabile

- ① pad printing / tampografia  
60 x 9 mm
- ② pad printing / tampografia  
43 x 9 mm
- ③ screen printing / serigrafia  
50 x 30 mm

## Features / Caratteristiche

twist-action / meccanismo a rotazione

made of non-toxic, highly resistant  
ABS plastic / realizzata in plastica ABS  
atossica e ad alta resistenza

Jumbo refill, blue and black ink / refill  
Jumbo, inchiostro blu e nero

available in glossy finish / disponibile  
con superfici lucide

Z1 — POST-CONSUMER RECYCLED PLASTIC  
PLASTICA RICICLATA POST-CONSUMO

Small imperfections and slight colour variations  
are to be considered intrinsic features of  
the recycled material deriving from the post-  
consumer sector. / Piccole imperfezioni e lievi  
variazioni cromatiche sono da considerarsi  
caratteristiche intrinseche del materiale riciclato  
derivante dal post-consumo.

**Fast Dry Gel** blue and black ink available  
on request /  
*Refill Gel Fast Dry blu e nero disponibile  
su richiesta*

# View

---



Decisive personality.  
*Carattere incisivo.*

---

Exudes boldness from every angle and captivates with its elegance.

*Sprigiona grinta da ogni punto di vista e affascina per l'eleganza.*



Technical information at p. 193  
*Informazioni tecniche a pag. 193*

---

V1

C CR / C CR T

Solid colours with glossy finish,  
metal chrome finish clip, chromed tip

V1 - C CR clip per incisione laser /  
clip for laser engraving

V1 - C CR T clip per tampografia /  
clip for pad printing



01

70

03

18

15

74

61

71

60 pink / laser engraving 30 x 7 mm  
60 rosa / incisione laser 30 x 7 mm

Colori coprenti con finitura lucida,  
clip in metallo cromato,  
punta cromata

79 lime / screen printing 42 x 30 mm  
79 lime / serigrafia 42 x 30 mm



25

73

09

75

27

64

12

04

22 blue / pad printing on the clip 40 x 6 mm  
22 blu / tampografia su clip 40 x 6 mm

V1

30 CR / 30 CR T

**V1 – 30 CR** clip per incisione laser /  
clip for laser engraving

**V1 – 30 CR T**  
clip per tampografia /  
clip for pad printing

Transparent colours with glossy finish,  
metal chrome finish clip, chromed tip

*Colori trasparenti con finitura lucida,  
clip in metallo cromato, punta cromata*



52

53

45

51

55

49

47

44

40

39 neutral / screen printing 42 x 30 mm  
39 neutro / serigrafia 42 x 30 mm

V1

## AL CR / AL CR T

**V1 – AL CR** clip per incisione laser /  
clip for laser engraving

**V1 – AL CR T**  
clip per tampografia /  
clip for pad printing

aluminium / laser engraving 30 x 7 mm  
alluminio / incisione laser 30 x 7 mm



Aluminium painted finish barrel and cap, metal chromed clip, chromed tip

*Fusto e cappuccio verniciati in colore alluminio, clip in metallo cromato, punta cromata*

The sleek design of the cap adds elegance and balances the large clip.

La linea affilata del cappuccio dà armonia e bilancia l'imponenza della clip.

V1

## GOM C CR / GOM C CR T

### V1 - GOM C CR

clip per incisione laser /  
clip for laser engraving

### V1 - GOM C CR T

clip per tampografia /  
clip for pad printing

Solid colour barrel and cap with  
rubber finish, metal chrome clip,  
chromed tip

Free rein to  
colours on  
metals too.



03

15

74

60

71

25

72

18 orange /  
pad printing on the clip 40 x 6 mm  
18 arancio /  
tampografia su clip 40 x 6 mm

61 magenta /  
screen printing 42 x 30 mm  
61 magenta /  
serigrafia 42 x 30 mm

*Fusto e cappuccio in colore coprente  
gommato, clip in metallo cromato,  
punta cromata*

Via libera ai colori,  
anche su metallo.

64 pastel blue / laser engraving 30 x 7 mm  
64 azzurro pastello / incisione laser 30 x 7 mm



73

79

09

75

27



12

22



04 black / pad printing  
on the clip 40 x 6 mm  
04 nero / tampografia  
su clip 40 x 6 mm

Technical information  
*Informazioni tecniche*

# View

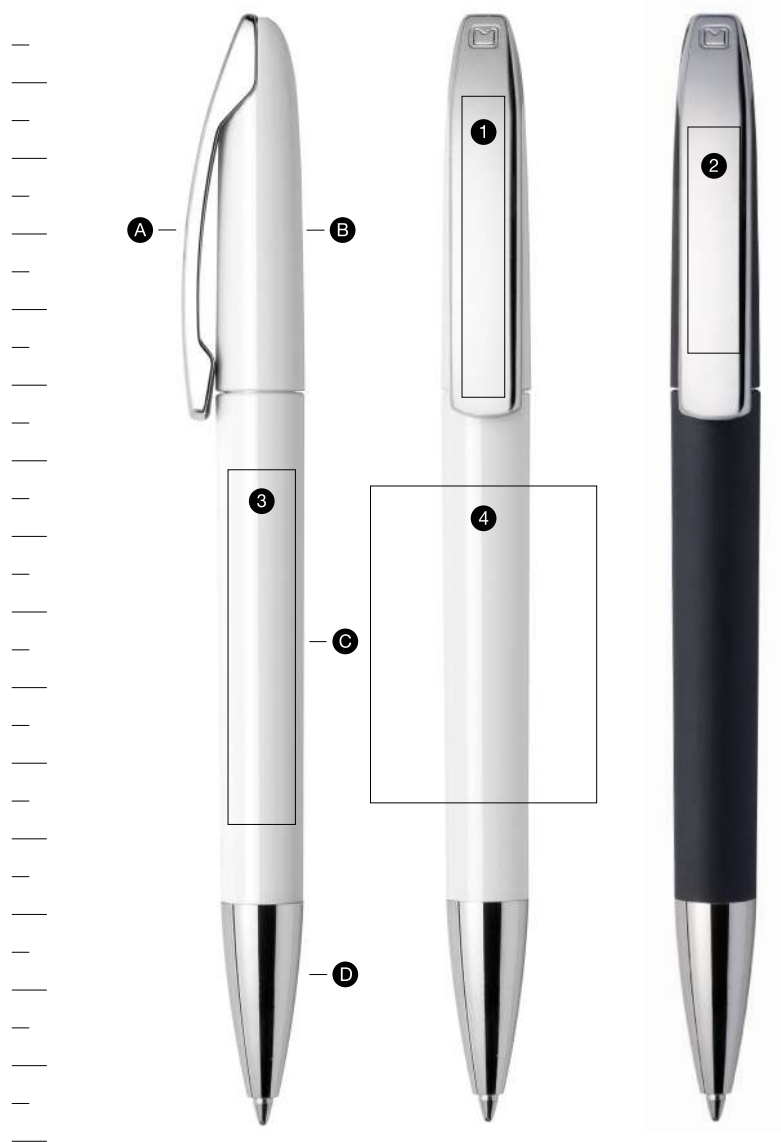

ø 11,3 mm  
h 137,4 mm



The entire Maxema collection is available  
in post-consumer recycled plastic on request /  
*Tutta la collezione Maxema è realizzabile  
in plastica riciclata post-consumo su richiesta*

## Components / Componenti

- A Clip
- B Cap / cappuccio
- C Barrel / fusto
- D Punta / tip

## Print area / Area stampabile

- 1 pad printing / tampografia  
40 x 6 mm
- 2 laser engraving 30 x 7 mm  
incisione laser 30 x 7 mm
- 3 pad printing / tampografia  
47 x 9 mm
- 4 screen printing / serigrafia  
42 x 30 mm

## Features / Caratteristiche

twist-action / meccanismo a rotazione

made of non-toxic, highly resistant ABS  
plastic / realizzata in plastica ABS  
atossica e ad alta resistenza

metal chrome finish clip available  
for laser engraving and pad printing /  
clip in metallo cromato, disponibile  
per incisione laser e tampografia

galvanic process used to chrome tip /  
la cromatura della punta è ottenuta  
con trattamento galvanico

Jumbo refill, blue and black ink / refill  
Jumbo, inchiostro blu e nero

available in glossy, rubberised  
or aluminium painted finish / disponibile  
con superfici lucide, gommate  
o verniciate in colore alluminio

**Fast Dry Gel** blue and black ink available  
on request /  
*Refill Gel Fast Dry blu e nero disponibile  
su richiesta*

# Tag

---



Imposing elegance.  
*Eleganza imponente.*

---

Clean-cut, refined  
design, a tribute  
to perfect elegance.

*Design semplice  
e raffinato, omaggio  
all'eleganza perfetta.*



Technical information at p. 203  
*Informazioni tecniche a pag. 203*

---

TA1 | MATT AL B

Solid white colour barrel and clip with matt finish, solid colour upper plug with glossy finish, aluminium painted finish tip

01 white / pad printing 40 x 9 mm  
01 bianco / tampografia 40 x 9 mm  
—  
screen printing 42 x 30 mm  
serigrafia 42 x 30 mm



03      18      15      74

61 magenta / pad printing 40 x 9 mm  
61 magenta / tampografia 40 x 9 mm



71      25

*Fusto e clip in colore bianco  
coprente con finitura satinata,  
tassello superiore in colori  
coprenti con finitura lucida,  
punta verniciata in colore alluminio*



72

73

79

09

27



12

22

04

64 pastel blue / pad printing 40 x 9 mm  
64 azzurro pastello / tampografia 40 x 9 mm

TA1 | B CR

Solid white colour barrel and clip,  
solid colour upper plug, glossy  
finishes, chromed tip

Elegance and  
linearity to express  
all the strength  
of a brand.

15 red / pad printing 40 x 9 mm  
15 rosso / tampografia 40 x 9 mm



03

18

74

61

09

27

12

22



*Fusto e clip in colore bianco, tassello superiore in colori coprenti, finiture lucide, punta cromata*

Eleganza e linearità per esprimere tutta la forza di un brand.

04 black / pad printing 40 x 9 mm  
04 nero / tampografia 40 x 9 mm

TA1 | C CR

Solid colours with glossy finish,  
chromed upper plug and tip

01 white / pad printing 40 x 9 mm  
01 bianco / tampografia 40 x 9 mm



70

03

18

15

74

60

61

71

25

72

Colori coprenti con finitura lucida,  
tassello superiore e punta cromati

64 pastel blue / pad printing 40 x 9 mm  
64 azzurro pastello / tampografia 40 x 9 mm



79      09      75      27

73 brown / pad printing 40 x 9 mm  
73 marrone / tampografia 40 x 9 mm



12      22      04

Technical information  
*Informazioni tecniche*

# Tag

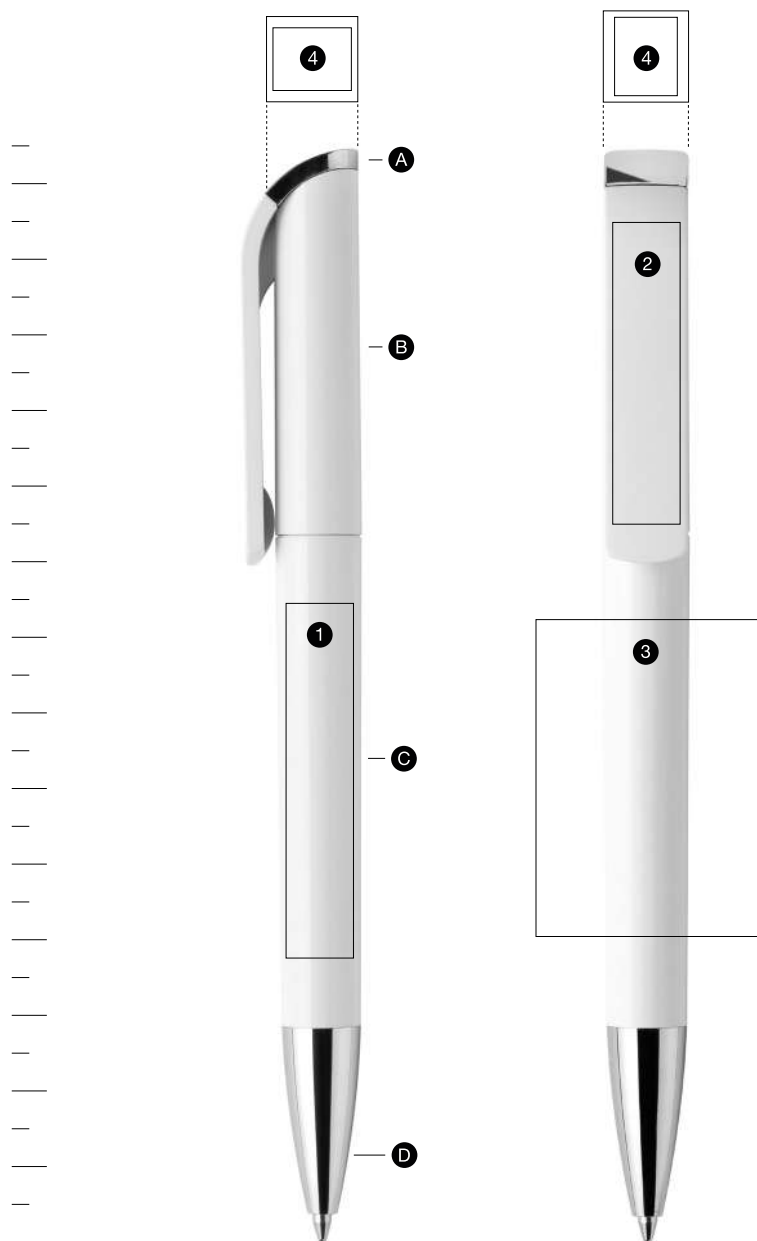

ø 11,3 mm  
h 140 mm



The entire Maxema collection is available  
in post-consumer recycled plastic on request /  
*Tutta la collezione Maxema è realizzabile  
in plastica riciclata post-consumo su richiesta*

## Components / Componenti

- A Plug / tassello
- B Clip / clip
- C Barrel / fusto
- D Tip / punta

## Print area / Area stampabile

- 1 pad printing / tampografia  
47 x 9 mm
- 2 pad printing / tampografia  
40 x 9 mm
- 3 screen printing / serigrafia  
42 x 30 mm
- 4 pad printing / tampografia  
8 x 10 mm

## Features / Caratteristiche

twist-action / meccanismo a rotazione

made of non-toxic, highly resistant  
ABS plastic / realizzata in plastica ABS  
atossica e ad alta resistenza

galvanic process used to chrome tip  
and upper plug / la cromatura della  
punta e del tassello superiore  
è ottenuta con trattamento galvanico

Jumbo refill, blue and black ink /  
refill Jumbo, inchiostro blu e nero

available in glossy and matt finish /  
disponibile con superfici  
lucide e satinare

**Fast Dry Gel** blue and black ink available  
on request /  
*Refill Gel Fast Dry blu e nero disponibile  
su richiesta*

# Icon

---



Timeless design.  
*Design senza tempo.*

---

A perfect synthesis of  
past, present and future.

*L'incontro tra passato,  
presente e futuro.*



Technical information at p. 215  
*Informazioni tecniche a pag. 215*

---



01

70

03

15

74

60

61

25

18 orange /  
pad printing 35 x 7 mm  
18 arancio /  
tampografia 35 x 7 mm

71 light violet /  
pad printing 35 x 7 mm  
71 viola chiaro /  
tampografia 35 x 7 mm

Colori coprenti con finitura satinata,  
punta verniciata in colore alluminio



72

73

79

09

75

27 octan green / pad printing 35 x 7 mm  
27 ottanio / tampografia 35 x 7 mm



64

12

22

04 black /  
screen printing 40 x 30 mm  
04 nero /  
serigrafia 40 x 30 mm



IC400 | C CR

Solid colours with glossy finish,  
chromed tip



01 white / pad printing 45 x 9 mm  
01 bianco / tampografia 45 x 9 mm



70



03



18



15



74



60



61 magenta / pad printing 35 x 7 mm  
61 magenta / tampografia 35 x 7 mm



71



25

Colori coprenti con finitura lucida,  
punta cromata

73 brown / pad printing 35 x 7 mm  
73 marrone / tampografia 35 x 7 mm



72



79

09



27

64

12

22

04

75 dark green / pad printing 35 x 7 mm  
75 verde scuro / tampografia 35 x 7 mm

IC400 | 30 CR

Transparent colours with  
glossy finish, chromed tip

*Colori trasparenti con finitura  
lucida, punta cromata*



39



52



53



45 red / pad printing 35 x 7 mm  
45 rosso / tampografia 35 x 7 mm



51



55



49



47 aquamarine /  
pad printing 35 x 7 mm  
47 acquamarina /  
tampografia 35 x 7 mm



44



40

Transparent colours with  
glossy finish, chromed tip

*Colori trasparenti con finitura  
lucida, punta cromata*

IC400 | C GOLD

Solid colours with glossy finish,  
gilded tip

*Colori coprenti con finitura lucida,  
punta dorata*

04 black / screen printing 40 x 30 mm  
04 nero / serigrafia 40 x 30 mm



01



74



75



22

IC400 | AL CR



Aluminium painted finish barrel and cap, chromed tip

*Fusto e cappuccio verniciati in colore alluminio, punta cromata*

aluminium / pad printing  
35 x 7 mm  
alluminio / tampografia  
35 x 7 mm

Technical information  
*Informazioni tecniche*

# Icon

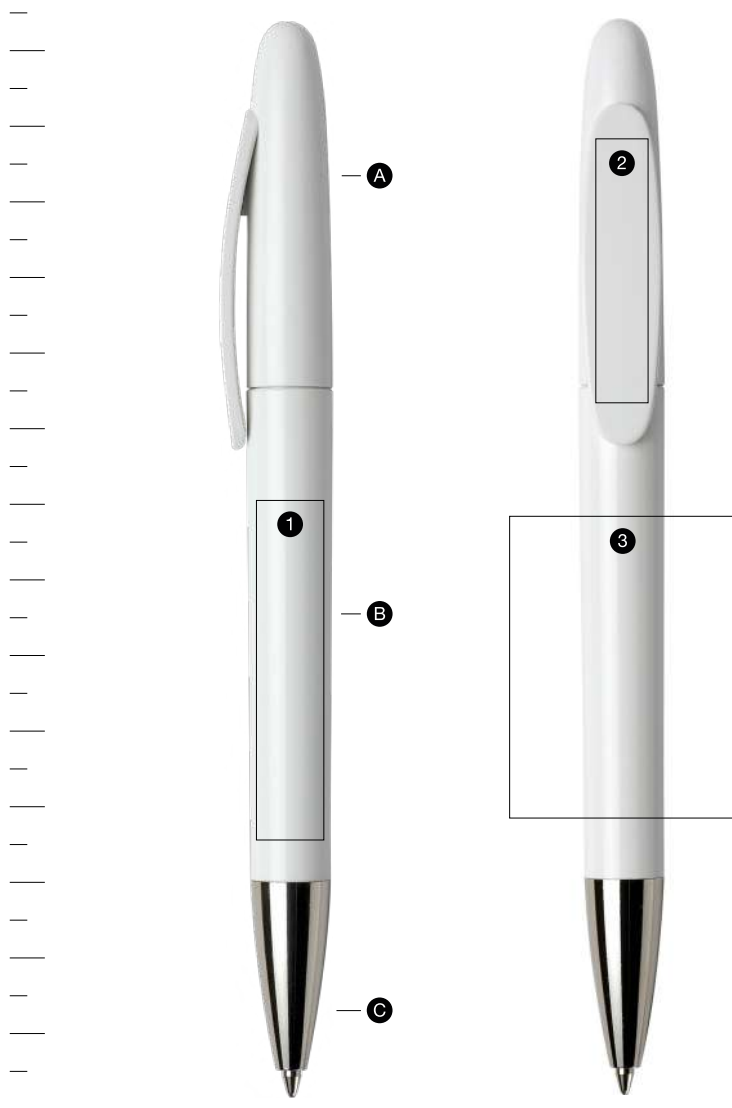

ø 11,3 mm  
h 138,2 mm



The entire Maxema collection is available  
in post-consumer recycled plastic on request /  
*Tutta la collezione Maxema è realizzabile  
in plastica riciclata post-consumo su richiesta*

## Components / Componenti

- Ⓐ Cap / cappuccio
- Ⓑ Barrel / fusto
- Ⓒ Tip / punta

## Print area / Area stampabile

- ① pad printing / tampografia  
45 x 9 mm
- ② pad printing / tampografia  
35 x 7 mm
- ③ screen printing / serigrafia  
40 x 30 mm

## Features / Caratteristiche

twist-action / meccanismo a rotazione

made of non-toxic, highly resistant  
ABS plastic / realizzata in plastica ABS,  
atossica e ad alta resistenza

galvanic process used to chrome and  
gild ABS tip / la cromatura e la doratura  
della punta in ABS sono ottenute  
con trattamento galvanico

Jumbo refill, blue and black ink / refill  
Jumbo, inchiostro blu e nero

available in glossy, matt and aluminium  
painted finish / disponibile con superfici  
lucide, satinare o alluminio

**Fast Dry Gel** blue and black ink available  
on request /  
*Refill Gel Fast Dry blu e nero disponibile  
su richiesta*

# Ethic

---



Elegance and flexibility.  
*Eleganza e flessibilità.*

---

Tailored to the  
customer's  
requirements.

*Costruita a misura  
di cliente.*



Technical information at p. 225  
*Informazioni tecniche a pag. 225*

---

## ET900 | MULTICOLOUR

Solid colours with glossy finish,  
metal chrome finish clip, chromed tip

*Colori coprenti con finitura lucida,  
clip in metallo cromato,  
punta cromata*

Designed to  
outlast passing  
fashions, like  
the message  
it conveys



G green / pad printing 55 x 9,5 mm  
G verde / tampografia 55 x 9,5 mm

Pensata per  
durare oltre  
le mode del  
momento, come  
il messaggio che  
deve trasmettere

## ET900 | FLAG

Solid colours with glossy finish, metal chrome finish clip, chromed tip

*Colori coprenti con finitura lucida, clip in metallo cromato, punta cromata*



FR

SP

GE

IT / pad printing 55 x 9,5 mm  
IT / tampografia 55 x 9,5 mm

## ET900 | C FLAG

Solid colours with glossy finish, metal chrome finish clip, chromed tip

*Colori coprenti con finitura lucida, clip in metallo cromato, punta cromata*



22 IT

04 IT / pad printing 55 x 9,5 mm  
04 IT / tampografia 55 x 9,5 mm

09



netcity

ET900 | B

Solid colours with glossy finish, metal chrome finish clip, metal chrome tip

*Colori coprenti con finitura lucida, clip in metallo cromato, punta cromata*



ET900 | BC

Solid colours with glossy finish,  
metal chrome finish clip, white top,  
chromed tip and two rings

*Colori coprenti con finitura lucida,  
clip in metallo cromato, due anelli  
e punta cromati, tappino bianco*

01



70

03

18

74

09

27

12

22

04

15 red / pad printing 30 x 8 mm  
15 rosso / tampografia 30 x 8 mm

—  
screen printing 45 x 30 mm  
serigrafia 45 x 30 mm

ET900 | C CR

Solid colours with glossy finish, metal chrome finish clip, chromed tip, top and two rings

*Colori coprenti con finitura lucida, clip in metallo cromato, due anelli, punta e tappino cromati*

chrome



01

70

SAP FORUM | SUGMENA CONFERENCE

18

15

03 yellow /  
pad printing  
55 x 9,5 mm  
03 giallo /  
tampografia  
55 x 9,5 mm

ALFALUX

25

09

75

27

74 burgundy /  
pad printing  
55 x 9,5 mm  
74 bordeaux /  
tampografia  
55 x 9,5 mm

## ET900 | C GOLD

Solid colours with glossy finish, gilded metal finish clip, gilded tip, top and two rings

*Colori coprenti con finitura lucida, clip in metallo dorato, due anelli, punta e tappino dorati*

The chrome or gilded details enhance the pen's elegance.

chrome



12

22

04

gold



74

27

22

04

Gynefam<sup>®</sup>  
ORO

01 white /  
screen printing  
45 x 30 mm  
01 bianco /  
serigrafia  
45 x 30 mm

I dettagli,  
cromati o dorati,  
ne esaltano  
l'eleganza.

Technical information  
*Informazioni tecniche*

# Ethic



ø 11,2 mm  
h 138,7 mm



The entire Maxema collection is available  
in post-consumer recycled plastic on request /  
*Tutta la collezione Maxema è realizzabile  
in plastica riciclata post-consumo su richiesta*

## Components / Componenti

- A Small cap / tappino
- B Cap / cappuccio
- C Rings / anelli
- D Barrel / fusto
- E Tip / punta

## Print area / Area stampabile

- 1 pad printing / tampografia  
30 x 8 mm
- 2 screen printing / serigrafia  
45 x 30 mm
- 3 pad printing / tampografia  
55 x 9,5 mm

## Features / Caratteristiche

twist-action / meccanismo a rotazione

made of non-toxic, highly resistant  
ABS plastic / realizzata in plastica ABS,  
atossica e ad alta resistenza

metal clip with chrome, or gilded finish /  
clip in metallo, con finitura cromata o  
dorata

galvanic process used to chrome  
or to gild ABS parts / la cromatura e  
la doratura delle parti in ABS sono  
ottenute con trattamento galvanico

Jumbo refill, blue and black ink / refill  
Jumbo, inchiostro blu e nero

available in glossy finish/ disponibile  
con superfici lucide

**Fast Dry Gel** blue and black ink available  
on request /  
*Refill Gel Fast Dry blu e nero disponibile  
su richiesta*

# Pixel

---



High resolution design.  
*Il design ad alta definizione.*

---

A synthesis of  
contemporary style.

*Sintesi dello stile  
contemporaneo.*



Also available in post-consumer recycled plastic /  
*Disponibile anche in plastica riciclata post-consumo*



Also available in white antibacterial plastic /  
*Disponibile anche in plastica antibatterica bianca*

---

Technical information at p. 249  
*Informazioni tecniche a pag. 249*

---

PX40 | MATT CB

Solid colour barrel with matt finish, solid glossy white colour clip and push-button

Colours with matt finish and white clip: an easy, gritty combination.



70

03

18

15

74

60

71

25

73

61 magenta / pad printing 30 x 8 mm  
61 magenta / tampografia 30 x 8 mm

*Fusto in colore coprente con finitura satinata, clip e tappino in colore bianco coprente lucido*

Colori con  
finitura matt e  
clip bianca: una  
combinazione  
facile e grintosa.



79

09

75

26

27

64

77

12

22

04

05 grey / pad printing 30 x 8 mm  
05 grigio / tampografia 30 x 8 mm

PX40 | MATT

Solid colour barrel with matt finish, solid glossy colour clip and push-button

A pop and colourful pen, with an unmistakable style.



01

70

03

18

15

74

60

61

71

25

73

Fusto in colore coprente con finitura satinata, clip e tappino in colore coprente lucido

Una penna pop e colorata, dallo stile inconfondibile.

75 dark green / pad printing 30 x 8 mm  
75 verde scuro / tampografia 30 x 8 mm



79

09

Sport LAND

26

27

64

77

12

22

ATMOSPHERA

04

05 grey / pad printing 30 x 8 mm  
05 grigio / tampografia 30 x 8 mm

PX40 | MATT CR

Solid colour barrel with matt finish, solid glossy colour clip, chromed push-button



01

70



03 yellow /  
pad printing  
30 x 8 mm  
03 giallo /  
tampografia  
30 x 8 mm



18



15



74



60



61



71



25

73 brown / pad printing 30 x 8 mm  
73 marrone / tampografia 30 x 8 mm



Fusto in colore coprente con finitura satinata, clip in colore coprente lucido, tappino cromato



79

09

75

26 aquamarine /  
pad printing  
30 x 8 mm  
26 acquamarina /  
tampografia  
30 x 8 mm



27



77



12



22



05



04

64 pastel blue / pad printing 60 x 9 mm  
64 azzurro pastello / tampografia 60 x 9 mm

Solid white colour barrel and push-button, solid colours clip, glossy finishes

*Fusto e tappino in colore bianco coprente, clip in colori coprenti, finiture lucide*



01      03      18      15



74 burgundy / pad printing 30 x 8 mm  
74 bordeaux / tampografia 30 x 8 mm



09      12



22 blue /  
pad printing  
30 x 8 mm  
22 blu /  
tampografia  
30 x 8 mm

PX40 | C

Solid colours with glossy finish

*Colori coprenti con finitura lucida*



70



03



18



15



09 green / pad printing 30 x 8 mm  
09 verde / tampografia 30 x 8 mm



12



22

04 black / pad printing 30 x 8 mm  
04 nero / tampografia 30 x 8 mm



PX40 | 30

Transparent colours  
with glossy finish

*Colori trasparenti  
con finitura lucida*

47 aquamarine /  
pad printing  
30 x 8 mm 47 ac-  
quamarina /  
tampografia  
30 x 8 mm



39

52

53

45

51

55

49



44

40

PX40 | FROST NEUTRAL

Transparent colours, matt finish barrel,  
glossy finish clip and push-button

*Colori trasparenti,  
fusto con finitura satinata,  
clip e tappino con finitura lucida*



53 orange /  
pad printing  
30 x 8 mm  
53 arancio /  
tampografia  
30 x 8 mm

55 dark violet /  
pad printing  
30 x 8 mm  
55 viola scuro /  
tampografia  
30 x 8 mm

52

45

51

49

47

44

40

PX40 | FROST

Transparent colours, matt finish barrel, glossy finish clip and push-button



39      52      53      45      59

41 magenta / pad printing 30 x 8 mm  
41 magenta / tampografia 30 x 8 mm



31 lilac /  
pad printing  
30 x 8 mm  
31 lilla /  
tampografia  
30 x 8 mm

51      55

*Colori trasparenti,  
fusto con finitura satinata,  
clip e tappino con finitura lucida*



37

38

49

34

67

44

40

50

78 lime / pad printing 30 x 8 mm  
78 lime / tampografia 30 x 8 mm

PX40 | GOM C CR

Solid colour barrel with rubber finish, solid colour clip with glossy finish, chromed push-button

*Fusto in colore coprente gommato, clip in colore coprente con finitura lucida, tappino cromato*



15 red / pad printing 30 x 8 mm  
15 rosso / tampografia 30 x 8 mm



18



74

61

25

79

09

22

04 black / pad printing 30 x 8 mm  
04 nero / tampografia 30 x 8 mm



PX40 | GOM 30 CR

Solid colour barrel with rubber finish, transparent colour clip with glossy finish, chromed push-button

*Fusto in colore coprente gommato, clip in colore trasparente con finitura lucida, tappino cromato*

47 aquamarine / pad printing 30 x 8 mm  
47 acquamarina / tampografia 30 x 8 mm



53

45



55

49



44

50

41 magenta /  
pad printing  
30 x 8 mm  
41 magenta /  
tampografia  
30 x 8 mm





PX40 | MATT CB RE

Post-consumer recycled plastic  
Solid colour barrel with matt finish,  
solid glossy white colour clip  
and push-button

Made of WEEE  
(Waste of Electrical  
and Electronic  
Equipment)  
recycled plastic.

RECYCLED PLASTIC POST-CONSUMER



10



87

76 desert / pad printing  
30 x 8 mm  
tampografia 30 x 8 mm

Extra customisation is available to  
tell the story of this pen's origin.  
Info at p. 277

*Disponibile una personalizzazione  
extra per raccontare l'origine di  
questa penna. Info a pag. 277*



*Plastica riciclata post-consumo  
Fusto in colore coprente con finitura  
satinata, clip e tappino in colore  
bianco coprente con finitura lucida*

Realizzata in  
plastica riciclata  
da RAEE (Rifiuti di  
Apparecchiature  
Elettriche ed  
Elettroniche).



19



21



07

58 graphite / pad printing 30 x 8 mm  
tampografia 30 x 8 mm

**Download  
Post-consumer  
Recycled  
Collection  
Catalogue**

Scarica il catalogo  
Post-consumer  
Recycled  
Collection





PX40 | MATT RE

RECYCLED PLASTIC POST-CONSUMER RECYCLED PLASTIC

06



10



76



87

Post-consumer recycled plastic  
Solid colour barrel with matt finish,  
solid glossy colour clip and push-button

Guaranteed  
and certified  
post-consumer  
recycled plastic  
of European origin.



Universal reclosable single pen case  
in Fedrigoni recycled paper Ardesia.  
Info at p. 288

*Astuccio universale richiudibile per  
penna singola in cartoncino riciclato  
Fedrigoni Ardesia.  
Info pag. 288*



21



58



07

19 forest / pad printing 30 x 8 mm  
tampografia 30 x 8 mm

*Plastica riciclata post-consumo  
Fusto in colore coprente  
con finitura satinata, clip e tappino  
in colore coprente con finitura lucida*

Plastica riciclata  
post-consumo  
di provenienza  
europea, garantita  
e certificata.

**Download  
Post-consumer  
Recycled  
Collection  
Catalogue**

Scarica il catalogo  
Post-consumer  
Recycled  
Collection



PX40 | MATT CB AB

Antibacterial plastic, solid white colour  
barrel with matt finish, solid glossy  
white clip and push-button

Safe, not just  
in words.



01



solid / coprenti

01

white  
bianco

*Plastica antibatterica, fusto in colore bianco coprente con finitura satinata, clip e tappino in colore bianco coprente lucido*

Sicura, non solo a parole.



Universal reclosable single pen case in Fedrigoni recycled paper Gesso. Info at p. 288

*Astuccio universale richiudibile per penna singola in cartoncino riciclato Fedrigoni Gesso. Info pag. 288*

**Download  
Antibacterial  
Pens  
catalogue**

Scarica il  
Catalogo  
Antibacterial  
Pens



Technical information  
*Informazioni tecniche*

# Pixel

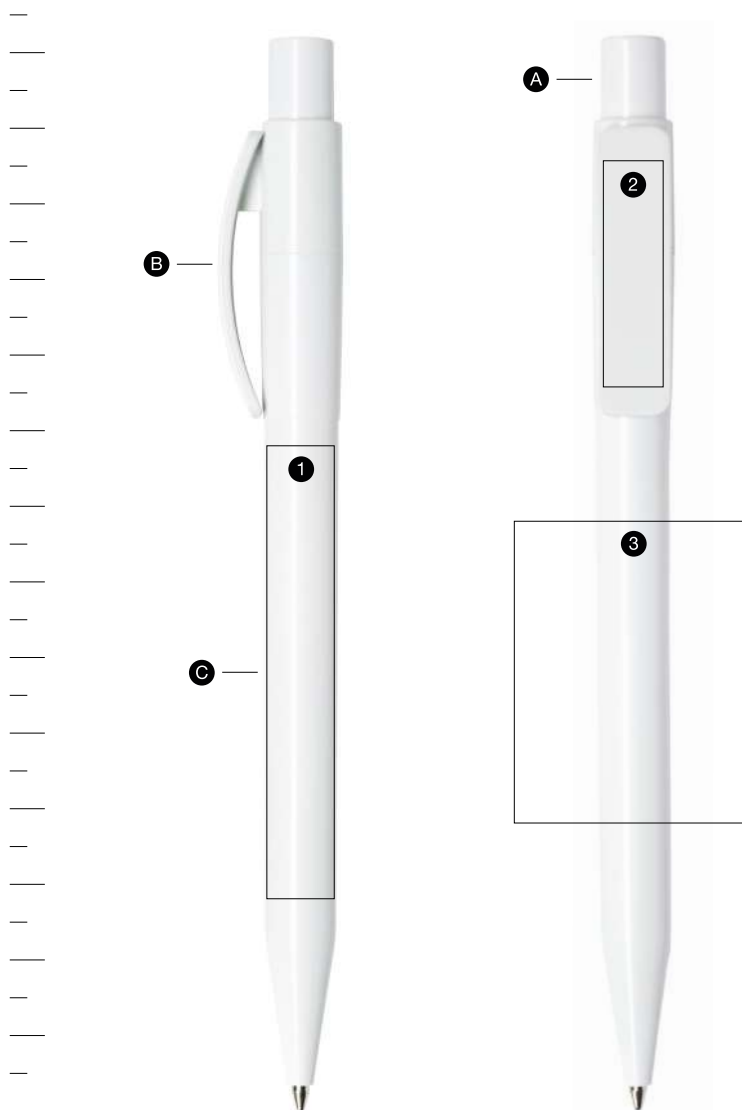

ø 10,2 mm  
h 140 mm



POST-CONSUMER  
RECYCLED PLASTIC

Pixel is available  
in post-consumer recycled plastic/  
*La penna Pixel è disponibile  
in plastica riciclata post-consumo*

ANTIBACTERIAL  
PLASTIC

Pixel is available  
in white antibacterial plastic/  
*La penna Pixel è disponibile  
in plastica antibatterica bianca*

## Components / Componenti

- Ⓐ Push-button / tappino
- Ⓑ Clip
- Ⓒ Barrel / fusto

## Print area / Area stampabile

- ① pad printing / tampografia  
60 x 9 mm
- ② pad printing / tampografia  
30 x 8 mm
- ③ screen printing / serigrafia  
40 x 31 mm

## Features / Caratteristiche

retractable / meccanismo a scatto

ventilated push-button / tappino ventilato

made of non-toxic, highly resistant  
ABS plastic / realizzata in plastica ABS,  
atossica e ad alta resistenza

X-20 refill, blue and black ink /  
refill X 20, inchiostro blu e nero

the barrel is available in glossy, matt  
or rubberised finish / il fusto  
è disponibile con superfici lucide,  
satinare o gommate

galvanic process used to chrome  
the ABS push-button / la cromatura  
del tappino in ABS è ottenuta con  
trattamento galvanico

 PX40 — POST-CONSUMER RECYCLED  
PLASTIC/ PLASTICA RICICLATA POST-CONSUMO

Small imperfections and slight colour variations  
are to be considered intrinsic features of  
the recycled material deriving from the post-consumer  
sector. / Piccole imperfezioni e lievi variazioni  
cromatiche sono da considerarsi caratteristiche  
intrinseche del materiale riciclato derivante dal post-  
consumo.

**Fast Dry Gel** blue and black ink available  
on request /  
*Refill Gel Fast Dry blu e nero disponibile  
su richiesta*

# Bay

---

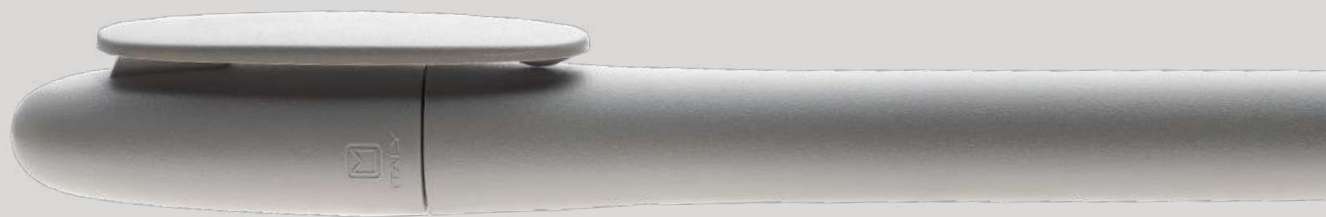

Casual and attractive  
*Disinvolta e accattivante*

---

Draws attention  
for its simplicity.

*Attrae per la  
sua semplicità.*



Also available in post-consumer recycled plastic /  
*Disponibile anche in plastica riciclata post-consumo*



Also available in white antibacterial plastic /  
*Disponibile anche in plastica antibatterica bianca*

---

Technical information at p. 265  
*Informazioni tecniche a pag. 265*

---

B500 | MATT BC

Solid white colour barrel,  
solid colours cap, matt finishes



70

03

18

15

74



61

71

25

73

79

60 pink / pad printing 30 x 7 mm  
60 rosa / tampografia 30 x 7 mm

*Fusto in colore bianco coprente,  
cappuccio in colori coprenti,  
finiture satinare*



75 dark green / pad printing 30 x 7 mm  
75 verde scuro / tampografia 30 x 7 mm  
—  
pad printing 60 x 7 mm  
tampografia 60 x 7 mm



09



26

27

64

77

12

22

05



04 black / pad printing 60 x 7 mm  
04 nero / tampografia 60 x 7 mm

B500 | MATT

Solid colours with matt finish

Effetto satinato:  
raffinata  
delicatezza  
in 22 colori.

01 white / pad printing 30 x 7 mm  
01 bianco / tampografia 30 x 7 mm



70

03

18

15

74

60

61

71

25

73 brown / pad printing 60 x 7 mm  
73 marrone / tampografia 60 x 7 mm



Job til unge på kanten

High:five

Colori coprenti con finitura satinata

Delicately refined  
matt finish in 22  
colours.



79

09

75

26

64

77

12

22

05

04

27 octan green / pad printing 30 x 7 mm  
27 ottanio / tampografia 30 x 7 mm

B500 | BC

Solid white colour barrel,  
solid colours cap, glossy finishes

*Fusto in colore bianco coprente,  
cappuccio in colori coprenti,  
finiture lucide*



03

18

15

25

09

12

04

**sorgenia**  
YOUR NEXT ENERGY

22 blue / pad printing 60 x 7 mm  
22 blu / tampografia 60 x 7 mm

B500 | C

Solid colours with glossy finish

*Colori coprenti con finitura lucida*



01

70

03

18

15

74

09

12

22

04 black / pad printing 30 x 7 mm  
04 nero / tampografia 30 x 7 mm





39

52

53



45 red /  
pad printing  
30 x 7 mm  
45 rosso /  
tampografia  
30 x 7 mm



51

55

49



47 aquamarine /  
pad printing  
30 x 7 mm  
47 acquamarina /  
tampografia  
30 x 7 mm



44

40

B500 | FROST

Transparent colours with matt finish  
*Colori trasparenti con finitura satinata*

55 dark violet / pad printing 30 x 7 mm  
55 viola scuro / tampografia 30 x 7 mm



52



53



45



51



49



44



40

39 neutral / pad printing 60 x 7 mm  
39 neutro / tampografia 60 x 7 mm



B500 | MATT RE



Post-consumer recycled plastic  
Solid colours with matt finish

Made of WEEE  
(Waste of Electrical  
and Electronic  
Equipment)  
recycled plastic.



06



10



76



87



Universal single pen case  
in Fedrigoni recycled paper  
Ardesia. Info at p. 280

Astuccio universale  
per penna singola  
in cartoncino riciclato  
Fedrigoni Ardesia.  
Info pag. 280



*Plastica riciclata post-consumo  
Colori coprenti con finitura satinata*

Realizzata in  
plastica riciclata  
da RAEE (Rifiuti di  
Apparecchiature  
Elettriche ed  
Elettroniche).



19



21



07

58 graphite / pad printing 30 x 7 mm  
tampografia 30 x 7 mm

Extra customisation is available to  
tell the story of this pen's origin.  
Info at p. 276

*Disponibile una personalizzazione  
extra per raccontare l'origine di  
questa penna. Info a pag. 276*

**Download  
Post-consumer  
Recycled  
Collection  
Catalogue**

Scarica il catalogo  
Post-consumer  
Recycled  
Collection



B500 | C AB

Antibacterial plastic, solid white colour with glossy finish

Protect your ideas,  
one message  
at a time.



01



solid / coprenti

01

white  
bianco

*Plastica antibatterica, colore bianco  
coprente con finitura lucida*

Proteggi  
le tue idee,  
un messaggio  
alla volta.



Universal reclosable single pen case  
in Fedrigoni recycled paper Gesso.  
Info at p. 288

*Astuccio universale richiudibile per  
penna singola in cartoncino riciclato  
Fedrigoni Gesso.  
Info pag. 288*

**Download  
Antibacterial  
Pens  
catalogue**

Scarica il  
Catalogo  
Antibacterial  
Pens



Technical information  
*Informazioni tecniche*

# Bay

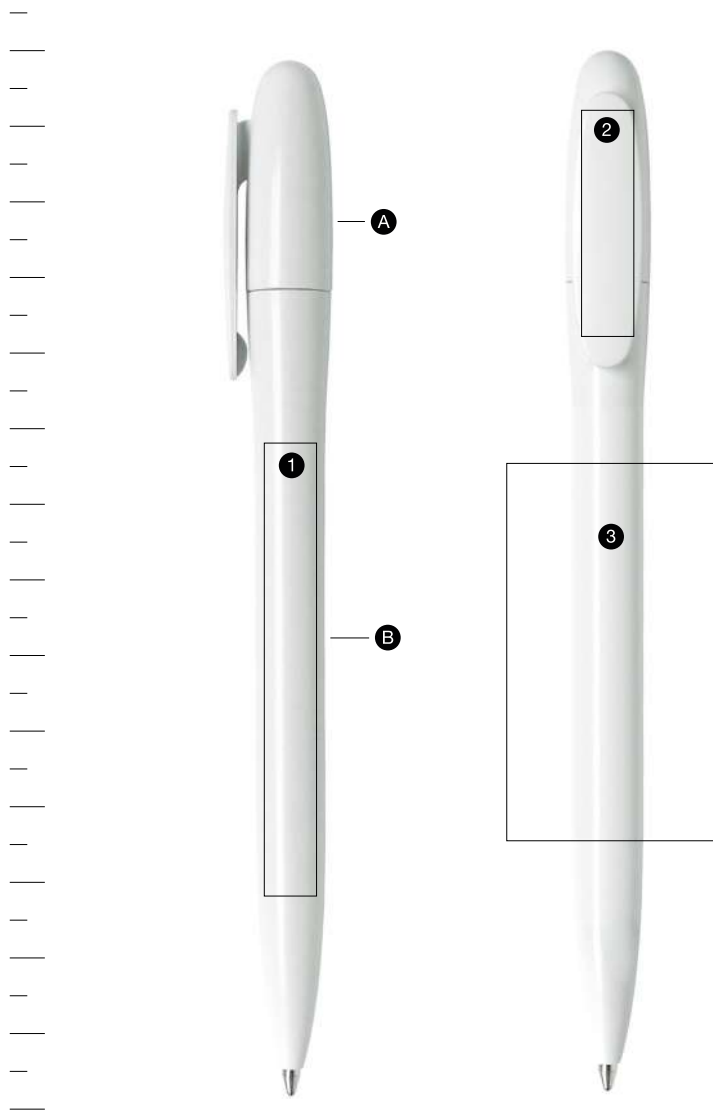

ø 10 mm  
h 135 mm



Bay is available  
in post-consumer recycled plastic/  
*La penna Bay è disponibile  
in plastica riciclata post-consumo*

ANTIBACTERIAL  
PLASTIC

Bay is available  
in white antibacterial plastic/  
*La penna Bay è disponibile  
in plastica antibatterica bianca*

## Components / Componenti

- A** Cap / cappuccio
- B** Barrel / fusto

## Print area / Area stampabile

- 1** pad printing / tampografia  
60 x 7 mm
- 2** pad printing / tampografia  
30 x 7 mm
- 3** screen printing / serigrafia  
50 x 28 mm

## Features / Caratteristiche

twist-action / meccanismo a rotazione

made of non-toxic, highly resistant  
ABS plastic / realizzata in plastica ABS,  
atossica e ad alta resistenza

X-20 refill, blue and black ink /  
refill X-20, inchiostro blu e nero

available in glossy or matt finish /  
disponibile con superfici lucide  
o satinete

 B500 – POST-CONSUMER RECYCLED  
PLASTIC/ PLASTICA RICICLATA POST-CONSUMO

Small imperfections and slight colour variations  
are to be considered intrinsic features of  
the recycled material deriving from the post-  
consumer sector. / Piccole imperfezioni e lievi  
variazioni cromatiche sono da considerarsi  
caratteristiche intrinseche del materiale riciclato  
derivante dal post-consumo.

**Fast Dry Gel** blue and black ink available  
on request /  
*Refill Gel Fast Dry blu e nero disponibile  
su richiesta*



Scopri tutto quello che c'è da sapere per rendere ancora più speciale una penna Maxema.

# More about Maxema

*Find out everything there is  
to know to make a Maxema  
pen even more special.*



## Fast and reliable *Veloci e affidabili*

p. 270

## Pen customisation *Personalizzazione penne*

p. 272

## Cases *Astucci*

p. 280

## Cases customisation *Personalizzazione astucci*

p. 290

## Sample Sets *Campionari*

p. 292

## Colour palette *Palette colori*

p. 304

## Inks and refills *Inchiostri e refill*

p. 306

# Fast and reliable

*Veloci e affidabili*

---

**Speedy Delivery**  
*Rapidità di consegna*

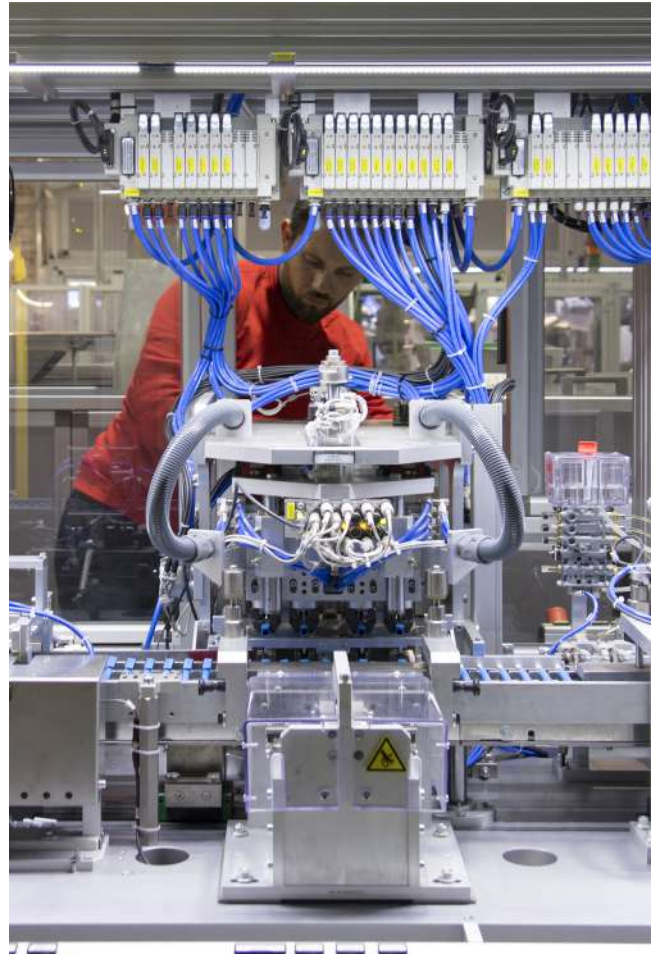

EN

The entire production process takes place at our plant where stringent quality controls are applied to test pen functionality and aesthetics. A team of specialists works on a daily basis to guarantee that every single pen meets our severe quality standards.

Large quantities of components are stored in our plant, ready for assembly by our highly automated machinery that is able to produce **from 2000 to 6000 pieces per hour**, guaranteeing speedy delivery times.

IT

L'intero processo produttivo si svolge all'interno del nostro stabilimento dove testiamo funzionalità ed estetica delle nostre penne con rigorosi controlli qualitativi. Un team di persone specializzate lavora ogni giorno per garantire che ogni singola penna risponda ai nostri severi standard di qualità.

Nel nostro stabilimento disponiamo di ingenti quantitativi di componenti e semi-lavorati pronti per essere assemblati da macchinari ad elevata automazione che assemblano **da 2.000 a 6.000 pezzi l'ora**: una garanzia di rapidità nei tempi di consegna.

# Pens customisation

*Personalizzazione penne*

---

Printing techniques  
*Tecniche di stampa*



1



2



3

EN

IT

Once assembled, the pen is ready to be customised with a logo, a QR Code or a message. Our Graphics Department will prepare digital simulations of possible alternatives and suggest new proposals to pinpoint the best result before going ahead with the printing.

Depending on logo features and what the pen is like, the Graphics Department gives its support and advice about what printing technique to use, including:

- 1 Pad printing
- 2 Screen printing
- 3 Laser engraving

Pad and screen printing are done using high-durability paints, while laser engraving allows you to customise even metal parts with elegance and precision. Once the print stage is completed the pens are put through strict quality controls. We can deliver printed pen samples on request. Contact our Sales Department for more information.

Una volta montata, la penna è pronta per essere personalizzata con un logo, un QR Code o un messaggio. Il nostro Studio Grafico elabora simulazioni digitali, propone alternative e suggerisce le soluzioni ottimali prima di procedere con la stampa.

In funzione delle caratteristiche del logo e della penna da personalizzare, lo Studio Grafico offre supporto e consulenza per individuare la migliore tecnica di stampa tra:

- 1 Tampografia
- 2 Serigrafia
- 3 Incisione laser

La tampografia e la serigrafia sono eseguite con uso di vernici ad alta tenuta, mentre l'incisione laser permette di personalizzare con eleganza e precisione anche le parti in metallo. Conclusa la fase di stampa, le penne sono sottoposte ad ulteriori e rigidi controlli qualitativi. Su richiesta realizziamo campioni stampati di singole penne. Contatta il nostro Ufficio Commerciale per maggiori informazioni.

# Extra imprint (on demand) / Personalizzazione extra (su richiesta)

R-PET



1

Back / retro  
IT

2

Back / retro  
EN

The sustainability choice needs to be communicated. So personalise your Kind with a message about this pen's origin.

-

*Una scelta sostenibile va comunicata. Personalizza la tua Kind con un messaggio che racconta l'identità di questa penna.*

Sentence available in other languages on request.

-

*Frases disponibles en otras lenguas su solicitud.*

## Pad printing / tampografia

1 53 x 3 mm

2 60 x 3 mm

# Extra imprint (on demand) / *Personalizzazione extra (su richiesta)*

PIR



①

Back / retro  
EN

②

Back / retro  
IT

Tell a story from the end.  
Customise your Zed with a  
message that also reveals  
the origin of the pen.

-

*Racconta una storia  
che comincia dalla fine.  
Personalizza Zed con un  
messaggio che descrive  
l'origine di questa penna.*

Sentence available in other  
languages on request.

-

*Frase disponibile in altre lingue  
su richiesta.*

**Pad printing / tampografia**

① 53 x 3 mm

② 60 x 3 mm

# Extra imprint (on demand)

## POST-CONSUMER RECYCLED COLLECTION



**Icon Pure  
Back**

Every pen has a story to tell, especially those made of post-consumer plastic. The customisation indicating the origin of the plastic used enhances the pen and the message it conveys.

You can customize with this sentence the models:

- **Icon Pure**
- **Flow Pure**
- **Dot**
- **Zink**
- **Pixel**
- **Bay**

Sentence available in other languages on request.  
*Frases disponibles en otras lenguas su riqhiesta.*

# Personalizzazione extra (su richiesta)

## PENNE IN PLASTICA RICICLATA POST-CONSUMO



**Dot  
Retro**

*Ogni penna ha una storia da raccontare, soprattutto quelle prodotte in plastica post-consumo. La personalizzazione che indica la provenienza del materiale plastico con cui è realizzata valorizza la penna e il messaggio che porta con sé.*

*Puoi personalizzare con questa frase i modelli:*

- **Icon Pure**
- **Flow Pure**
- **Dot**
- **Zink**
- **Pixel**
- **Bay**

### **Pad printing / tampografia**

**IT** 46 x 3 mm

**EN** 40 x 3 mm

# Mix&Match

---



To create an even more unique pen, **you can mix the colours and finishes available\***.

-

*Per creare una penna ancora più unica e speciale **è possibile mixare i colori e le finiture disponibili.\****

\*Please contact our Sales Office for prices and minimum order quantities.  
\*Contatta l'Ufficio Commerciale per prezzi e quantitativi minimi.

# Pantone Colours



Are 28 colours  
not enough?  
We can produce one or  
more pen components  
in a Pantone colour.\*

-  
*28 colori non bastano?  
È possibile realizzare  
una o più componenti  
della penna in un colore  
Pantone.\**

\*See the Price List for sales conditions  
and minimum order quantities.  
*\*Consulta il Listino Prezzi per condizioni  
di vendita e quantitativi minimi.*

# Cases

## My Case Recycled



**Fedrigoni recycled paper Ardesia /  
cartoncino riciclato Fedrigoni Ardesia**

The My Case pen box, suitable for all Maxema models, enhances the pen and highlights its message because it can be customised with pad or screen printing. The use of recycled cardboard makes it sustainable.

-  
*L'astuccio My Case, adatto a tutti i modelli Maxema, valorizza la penna e ne esalta il messaggio perché è personalizzabile in tampografia o serigrafia. In più è sostenibile, perché è in cartoncino riciclato.*

More examples of customisation on p. 280  
*Altri esempi di personalizzazione a pag. 280*



**Fedrigoni recycled paper Gesso /  
cartoncino riciclato Fedrigoni Gesso**

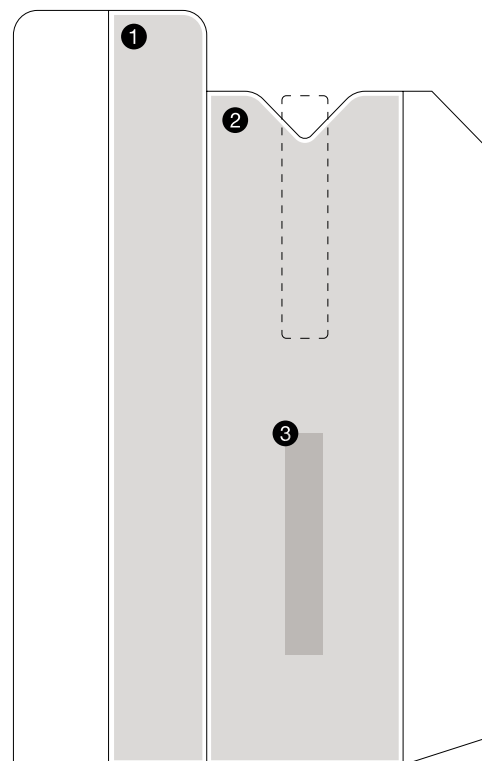

universal single pen case in Fedrigoni recycled paper Gesso and Ardesia 250 gr/m<sup>2</sup>, FSC-certified, personalisable with pad and screen printing

size: 44 x 168 mm

—  
*astuccio universale per penna singola in cartoncino Fedrigoni riciclato Gesso e Ardesia 250 gr/m<sup>2</sup>, certificato FSC, personalizzabile con stampa tampografica e serigrafica*

*dimensioni: 44 x 168 mm*

#### **Screen printing / serigrafia**

❶ 21 x 166 mm

❷ 43 x 148 mm

#### **Pad printing / tampografia**

❸ 50 x 9 mm

# My Case Kind



Fedrigoni recycled paper Gesso /  
cartoncino riciclato Fedrigoni Gesso

The My Case box in recycled cardboard for the Kind model completes the presentation of the pen and tells the story of the origin of the material it is made of, amplifying the message of attention and kindness towards the environment.

-  
*L'astuccio in cartoncino riciclato My Case per il modello Kind accompagna la penna e racconta la provenienza del materiale con cui è realizzata, amplificando il messaggio di cura e gentilezza verso l'ambiente.*



**Fedrigoni recycled paper Ardesia /  
cartoncino riciclato Fedrigoni Ardesia**

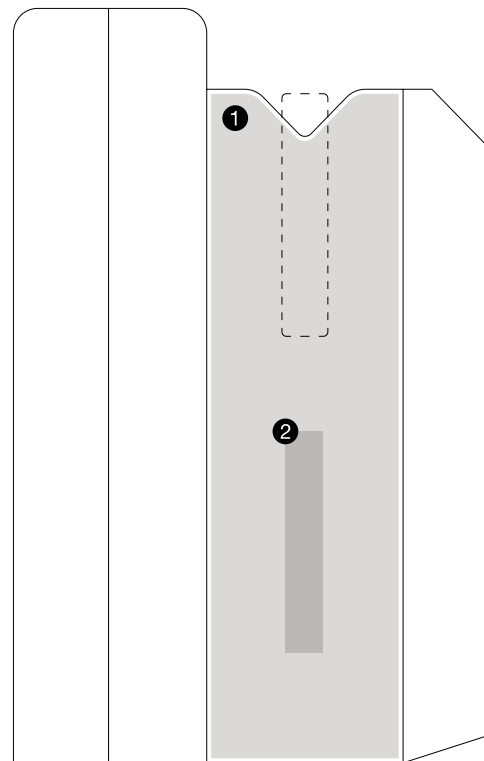

Kind single pen case in Fedrigoni recycled paper Gesso and Ardesia 250 gr/m<sup>2</sup>, FSC-certified, personalisable with pad and screen printing

size: 44 x 168 mm

—  
*astuccio Kind per penna singola in cartoncino Fedrigoni riciclato Gesso e Ardesia 250 gr/m<sup>2</sup>, certificato FSC, personalizzabile con stampa tampografica e serigrafica*

*dimensioni: 44 x 168 mm*

**Screen printing / serigrafia**

❶ 42 x 148 mm

**Pad printing / tampografia**

❷ 50 x 9 mm

# My Case Zed



A recycled paper case  
for a story ready to  
begin again

-  
*Un astuccio in  
carta riciclata, per  
contenere una storia  
pronta a ricominciare.*

**Fedrigoni recycled paper Materica Gesso /  
cartoncino riciclato Fedrigoni Materica Gesso**



**Fedrigoni recycled paper Materica Ardesia /  
cartoncino riciclato Fedrigoni Materica Ardesia**

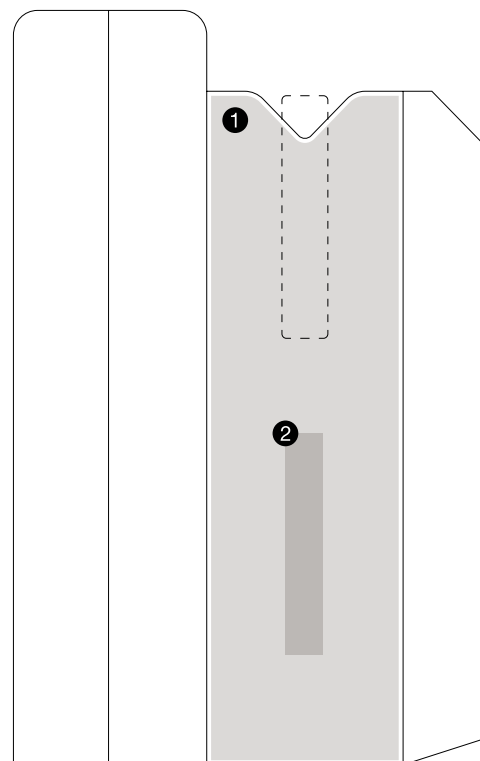

Zed single pen case in Fedrigoni recycled paper Materica Gesso and Ardesia 250 gr/m<sup>2</sup>, FSC-certified, personalisable with pad and screen printing

size: 44 x 168 mm

—  
*astuccio Zed per penna singola in cartoncino Fedrigoni riciclato Gesso e Ardesia 250 gr/m<sup>2</sup>, certificato FSC, personalizzabile con stampa tampografica e serigrafica*

*dimensioni: 44 x 168 mm*

**Screen printing / serigrafia**

❶ 42 x 148 mm

**Pad printing / tampografia**

❷ 50 x 9 mm

# My Case Post Consumer



**Fedrigoni recycled paper Materica Gesso /  
cartoncino riciclato Fedrigoni Materica Gesso**

Made from recycled and certified paper, this case is not just packaging: it's an integral part of your sustainable message.

-  
*Realizzato in carta riciclata e certificata, questo astuccio non è solo una custodia: è parte integrante del tuo messaggio sostenibile.*



**Fedrigoni recycled paper Materica Ardesia /  
cartoncino riciclato Fedrigoni Materica Ardesia**

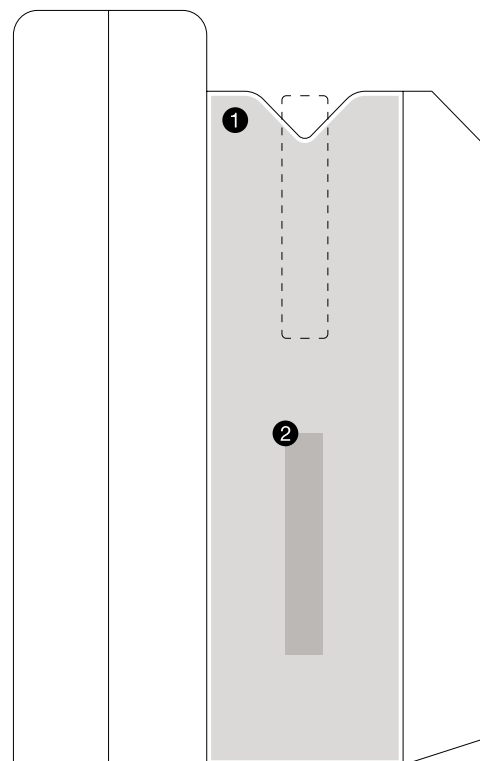

Single pen case in Fedrigoni recycled paper Materica Gesso and Ardesia 250 gr/m<sup>2</sup>, FSC-certified, personalisable with pad and screen printing

size: 44 x 168 mm

—  
*Astuccio per penna singola in cartoncino Fedrigoni riciclato Gesso e Ardesia 250 gr/m<sup>2</sup>, certificato FSC, personalizzabile con stampa tampografica e serigrafica*

*dimensioni: 44 x 168 mm*

**Screen printing / serigrafia**

❶ 42 x 148 mm

**Pad printing / tampografia**

❷ 50 x 9 mm

# My Box Recycled

---



**Fedrigoni recycled paper Gesso /  
cartoncino riciclato Fedrigoni Gesso**

**Fedrigoni recycled paper Ardesia /  
cartoncino riciclato Fedrigoni Ardesia**

I nostri astucci si prendono cura dell'ambiente.

# Our cases look after the environment.

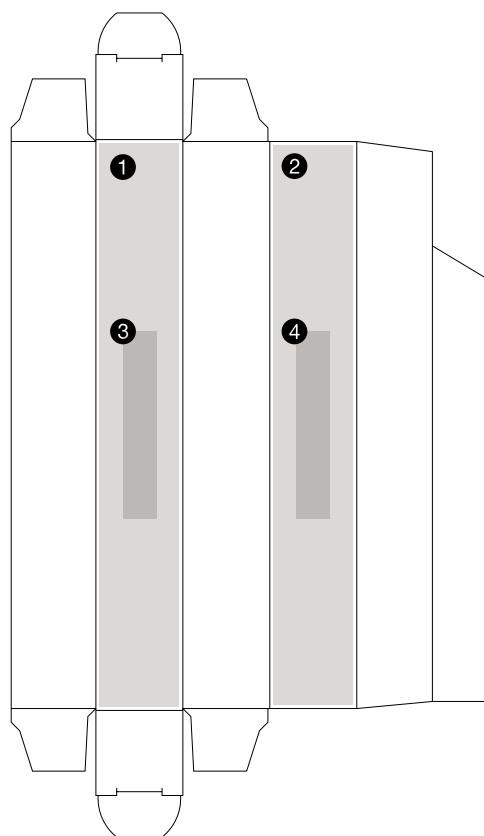

universal reclosable single pen case in Fedrigoni recycled paper Gesso and Ardesia 250 gr/m<sup>2</sup>, FSC-certified, personalisable with pad and screen printing

size: 23 x 151 x 23 mm

—  
*astuccio universale richiudibile per penna singola in cartoncino Fedrigoni riciclato Gesso e Ardesia 250 gr/m<sup>2</sup>, certificato FSC, personalizzabile con stampa tampografica e serigrafica*

*dimensioni: 23 x 151 x 23 mm*

**Screen printing /  
serigrafia**

① 148 x 20 mm

② 148 x 20 mm

**Pad printing /  
tampografia**

③ 50 x 9 mm

④ 50 x 9 mm

More examples of customisation on p. 280  
*Altri esempi di personalizzazione a pag. 280*

# Cases customisation

*Personalizzazione astucci*



1

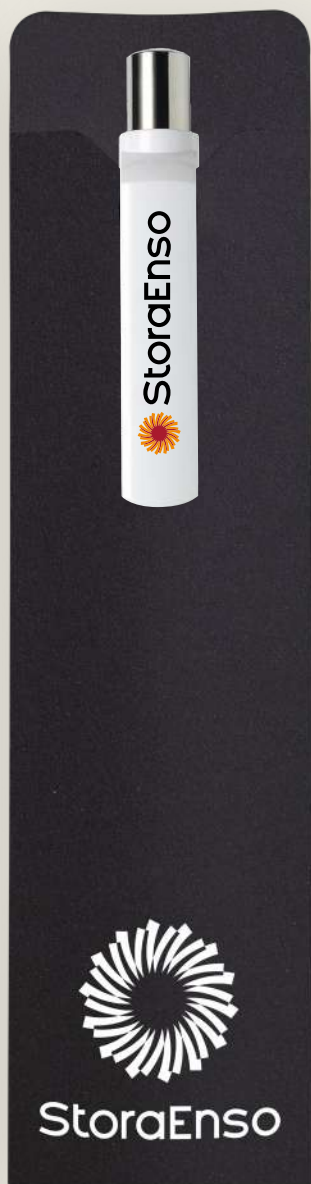

2



3



4

EN

Packaging can also be a communications medium. That's why our pen cases are made of environmentally-friendly materials and help tell the story of our and your care for the environment.

My Box and My Case are both customisable in two ways:

- **Standard** - with pad or screen printing
- **Custom** - with fully customised offset graphics

Contact our Sales Department for more information. In both events, each individual pen is inserted into its case and quality control is meticulous.

IT

Anche il packaging è uno strumento di comunicazione. Per questo i nostri astucci sono realizzati con materiali eco-friendly e contribuiscono a raccontare la nostra e la vostra attenzione verso l'ambiente.

My Box e My Case sono entrambi personalizzabili con due modalità:

- **Standard** – con stampa in tampografia o serigrafia
- **Custom** – con grafica interamente customizzata in offset

Contatta il nostro Ufficio Commerciale per richiedere maggiori informazioni. In entrambi i casi ogni singola penna viene inserita nel suo astuccio, con un meticoloso controllo qualità.

- 1 Pad printing / tampografia
- 2 Screen printing / serigrafia
- 3 Custom
- 4 Custom

# Sample sets

*Campionari*

EN

---

Our Minikits and Sample Kits are designed to present all our models in the various finishes and colours available. You can also request samples of individual pens, either neutral or printed.

IT

---

I nostri Minikit e Kit di campionatura sono pensati per presentare tutti i nostri modelli, nelle diverse finiture e colori disponibili. È possibile richiedere anche campioni di singole penne, neutri o stampati.

---

# Minikit

## MOOD METAL



Metal elegance in 3 different finishes and clip available in 23 shades.

*L'eleganza del metallo in 3 diverse finiture e clip disponibile in 23 colorazioni.*



3 Mood Metal in chrome, titanium grey and gold finish

size: 10,2 x 19 cm (closed format)

3 Mood Metal nelle finiture: cromato, grigio titanio e oro

dimensioni: 10,2 x 19 cm (formato chiuso)

# Minikit

## 8 PENS IN PIR PLASTIC



Contains 8 printed Zed pens in PIR ABS plastic, in assorted colours and logos.

size: 24,3 x 20 cm (closed format)

—  
Contiene 8 penne Zed in plastica ABS PIR personalizzate con colori e loghi assortiti.

dimensioni: 24,3 x 20 cm (formato chiuso)

# Minikit

## 8 R-PET PENS



Contains 8 printed KIND pens in R-PET plastic, in assorted colours and finishes.

size: 24,3 x 20 cm (closed format)

Contiene 8 penne KIND in plastica R-PET personalizzate, in colori e finiture assortite.

dimensioni: 24,3 x 20 cm (formato chiuso)

# Minikit

## 8 POST-CONSUMER RECYCLED PENS



Care for our planet can also be expressed through the choice of sustainable packaging. An FSC-certified minikit made of cellulose, certified recycled fibres and cotton fibres. Respect for the environment and sustainability guaranteed by an effective display tool.

contains 8 pens of one model, in all available colours

size: 24,3 x 20 cm (closed format)

—  
contiene 8 penne di un modello, in tutti i colori disponibili

dimensioni: 24,3 x 20 cm (formato chiuso)

# Minikit

## 6 POST-CONSUMER RECYCLED PENS

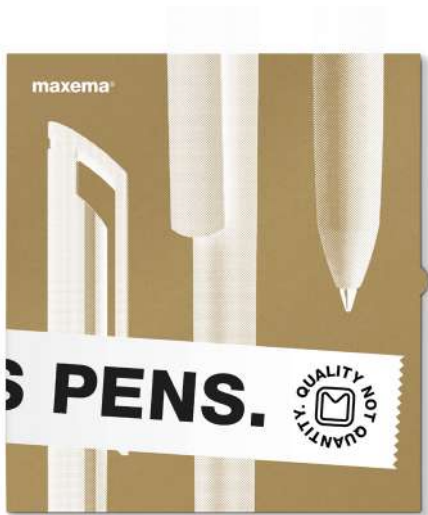

*L'attenzione verso il nostro pianeta si esprime anche attraverso la scelta di un packaging sostenibile. Un minikit certificato FSC composto da cellulosa, fibre di riciclo certificate e fibre di cotone. Rispetto dell'ambiente e sostenibilità garantite da un efficace strumento espositivo.*



contains 6 different recycled plastic models:  
Icon Pure, Flow Pure, Dot, Zink, Pixel and Bay

size: 19 x 19,8 cm (closed format)

contiene 6 diversi modelli di penne in plastica riciclata:  
Icon Pure, Flow Pure, Dot, Zink, Pixel e Bay

dimensioni: 19 x 19,8 cm (formato chiuso)

# Kit and box sets / Kit e raccoglitori

## KIT

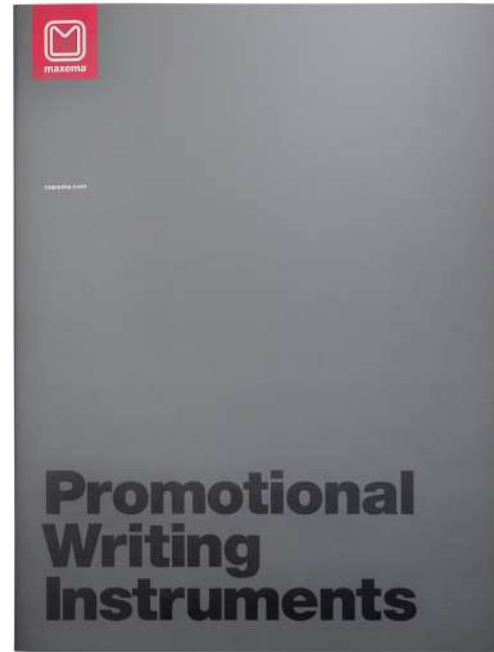

20 printed pens in assorted colours of the most representative models

size: 25 x 34 cm (closed format)

—  
20 penne stampate in colori assortiti dei modelli più rappresentativi

dimensioni: 25 x 34 cm (formato chiuso)

## BOX SETS / RACCOGLITORI

The Kits are available in 1, 2 or 3 unit box sets /  
i Kit sono disponibili in raccoglitori da 1, 2 o 3

- ❶ 28 x 33 x 3 cm
- ❷ 28 x 33 x 5,5 cm
- ❸ 28 x 33 x 8 cm

## MODEL KIT / KIT MODELLO

20 printed pens in assorted colours of a single model  
size: 25 x 34 cm (closed format)

—  
*20 penne stampate in colori assortiti di un unico modello  
dimensioni: 25 x 34 cm (formato chiuso)*

—  
the Model Kit is available for / *il Kit Modello*  
è disponibile per:  
Zed, Kind, Icon Pure, Mood Metal, Dot Antibacterial,  
Mood, Flow Pure, Flow, Dot, Zink, View, Tag, Icon, Icon  
Green, Tag Green, Ethic, Pixel, Next, Bay.



On request we can prepare customised sets of samples  
containing specific versions and colours of pens.

—  
*Su richiesta possiamo realizzare campionari  
personalizzati con penne di specifiche versioni e colori.*

# Kit Dot Antibacterial



Contains 20 printed Dot antibacterial in assorted colours

size: 25 x 34 cm (closed format)

—  
 Contiene 20 penne Dot in plastica antibatterica stampate in colori assortiti

dimensioni: 25 x 34 cm (formato chiuso)

# Minikit Antibacterial

Monochromatic presentation of the Antibacterial collection: white has always been a symbol of safety and protection.

*Presentazione monocromatica della collezione Antibacterial: il bianco è da sempre simbolo di sicurezza e protezione.*

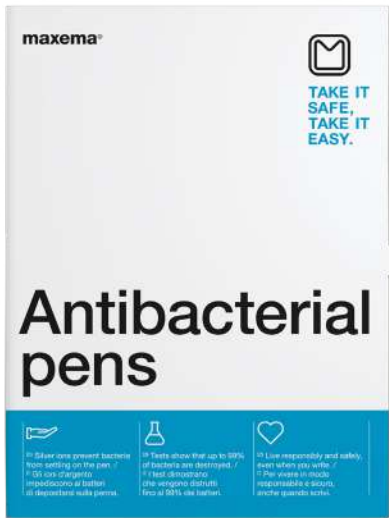

5 antibacterial printed pens in white colour

size: 10,2 x 19 cm (closed format)

—  
5 penne antibacterial bianche

dimensioni: 10,2 x 19 cm (formato chiuso)

# Minikit

## GENERAL / GENERICO

The essential selection of our best sellers: Minikits are valuable tools to display, consult and collect.

*La selezione essenziale dei nostri best seller: i Minikit sono strumenti preziosi da esporre, consultare, collezionare.*



5 printed pens in assorted colours of the most representative models

size: 14,7 x 19 cm (closed format)

*5 penne stampate in colori assortiti dei modelli più rappresentativi*

*dimensioni: 14,7 x 19 cm (formato chiuso)*



△ POST-CONSUMER RECYCLED PLASTIC PENS / PENNE IN PLASTICA RICICLATA POST-CONSUMO – solid / coprenti

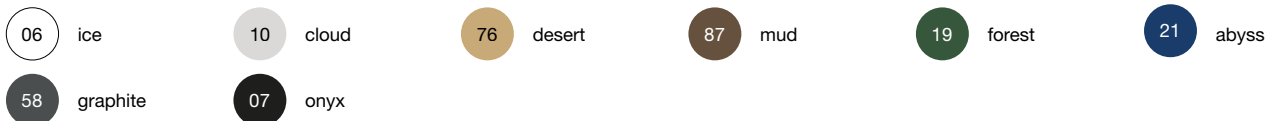

solid / coprenti



\*(Available only for Zed model / disponibile solo per il modello Zed)

transparent / trasparenti



\*(Available only for Kind model / disponibile solo per il modello Kind)

metallic paintings / vernici metallizzate



solid fluo / fluo coprenti

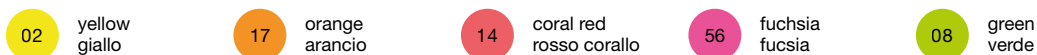

transparent fluo / fluo trasparenti



galvanic process / trattamento galvanico



metal finishes / finiture metallo



Our colour chart is shown below with the Pantone codes closest to those of our Palette. Matches are approximate.

In questa tabella sono riportati i nostri colori con i codici Pantone che più si avvicinano a quelli della nostra Palette. La corrispondenza è puramente indicativa.

solid / coprenti

01	white / bianco	
70	cream / crema	<b>pant 7499</b>
03	yellow / giallo	<b>pant 120</b>
18	orange / arancio	<b>pant 1505</b>
15	red / rosso	<b>pant 187</b>
74	burgundy / bordeaux	<b>pant 195</b>
60	pink / rosa	<b>pant 1905</b>
61	magenta	<b>pant 213</b>
71	light violet / viola chiaro	<b>pant 270</b>
25	dark violet / viola scuro	<b>pant violet</b>
72	leather / cuoio	<b>pant 7571</b>
73	brown / marrone	<b>pant 7582</b>
79	lime	<b>pant 381</b>
09	green / verde	<b>pant 348</b>
75	dark green / verde scuro	<b>pant 3435</b>
26	aquamarine / acquamarina	<b>pant 3262</b>
27	ocean green / ottanio	<b>pant 321</b>
64	pastel blue / azzurro pastello	<b>pant 283</b>
77	cyan / ciano	<b>pant 2995</b>
12	light blue / azzurro	<b>pant 285</b>
22	blue / blu	<b>pant 288</b>
05	grey / grigio	<b>pant cool gray 4</b>
04	black / nero	<b>pant black 6</b>
69	pastel green / verde pastello	<b>pant 374 C</b>
11	dark grey / grigio scuro	<b>PMS 424 C</b>
23	violet / viola	<b>PMS 2602 C</b>
16	bright red / rosso vivo	<b>PMS 1795 C</b>

trasparent / trasparenti

39	neutral / neutro	
52	yellow / giallo	<b>pant 116</b>
53	orange / arancio	<b>pant 1505</b>
45	red / rosso	<b>pant 200</b>
59	pink / rosa	<b>pant 1905</b>
41	magenta	<b>pant 213</b>
31	lilac / lilla	<b>pant 2705</b>
51	violet / viola	<b>pant 2425</b>
55	dark violet / viola scuro	<b>pant violet</b>
37	amber / ambra	<b>pant 7571</b>
38	brown / marrone	<b>pant 7582</b>
78	lime	<b>pant 381</b>
49	green / verde	<b>pant 348</b>
47	aquamarine / acquamarina	<b>pant 3272</b>
34	light blue / azzurro	<b>pant 283</b>
67	cyan / ciano	<b>pant 306</b>
44	blue / blu	<b>pant 286</b>
30	light grey / grigio chiaro	<b>pant cool gray 6</b>
40	grey / grigio	<b>pant 437</b>
32	pure grey / grigio puro	<b>pant 431</b>
50	dark grey / grigio scuro	<b>pant 446</b>

♻️ POST-CONSUMER RECYCLED PLASTIC PENS  
PENNE IN PLASTICA RICICLATA POST-CONSUMO

solid / coprenti

06	ice	
10	cloud	<b>pant cool gray 1 C</b>
76	desert	<b>pant 466 C</b>
87	mud	<b>pant 7532 C</b>
19	forest	<b>pant 7735 C</b>
21	abyss	<b>pant 654 C</b>
58	graphite	<b>pant 425 C</b>
07	onyx	

Pantone colours are available on demand. Please contact us to find out the minimum order quantity for each model.  
I colori Pantone sono disponibili su richiesta, contattateci per conoscere i quantitativi minimi per ogni modello.

# Inks and refills / *Inchiostri e refill*

INKS / INCHIOSTRI



blue  
blu



black  
nero



red (upon request)  
rosso (su richiesta)

## X-20



aluminium tip, stainless steel ball Ø 1 mm, length 107 mm, for up to 2000 meters of writing

*punta in alluminio, sfera in acciaio inossidabile, Ø 1 mm, lunghezza 107 mm, fino a 2000 metri di scrittura*

## JUMBO



aluminium tip, stainless steel ball Ø 1 mm, length 107 mm,  
for up to 2500 metres of writing

*punta in alluminio, sfera in acciaio inossidabile Ø 1 mm, tubetto in polipropilene,  
lunghezza 107 mm, fino a 2500 metri di scrittura*

**The ink is Dokumental.**  
All Dokumental inks comply  
with European REACH and American  
TSCA standards.

—  
**L'inchiostro, è Dokumental.**  
Tutti gli inchiostri Dokumental sono  
conformi alla normativa europea REACH  
e americana TSCA.

## RT90 PARKER TYPE BLACK TUBE, BRANDED WITH MAXEMA LOGO ON DEMAND / RT90 TIPO PARKER TUBO NERO CON LOGO MAXEMA SU RICHIESTA



nickel-silver brass tip, tungsten carbide ball Ø 1 mm, polypropilene barrel,  
length 98 mm, for up to 4000 metres of writing

*punta in ottone nichelato, sfera in carburo di tungsteno, Ø 1 mm,  
tubetto in polipropilene, lunghezza 98 mm, fino a 4000 metri di scrittura*

**The ink is Dokumental.**  
All Dokumental inks comply  
with European REACH and American  
TSCA standards.

—  
**L'inchiostro, è Dokumental.**  
Tutti gli inchiostri Dokumental sono  
conformi alla normativa europea REACH  
e americana TSCA.

## RT90 PARKER TYPE TUBO BIANCO ON DEMAND RT90 TIPO PARKER TUBO BIANCO SU RICHIESTA



nickel-silver brass tip, tungsten carbide ball Ø 1 mm, polypropilene barrel,  
length 98 mm, for up to 4000 metres of writing

*punta in ottone nichelato, sfera in carburo di tungsteno, Ø 1 mm,  
tubetto in polipropilene, lunghezza 98 mm, fino a 4000 metri di scrittura*

## GEL FAST DRY ON DEMAND / SU RICHIESTA



titanium carbide ball (SS, TC), Ø 0.7 mm, tip in stainless steel, length 98 mm,  
up to 700 meters of writing

*sfera in carburo di titanio (SS, TC) Ø 0,7 mm, punta in acciaio inox,  
lunghezza 98 mm, fino a 700 metri di scrittura*

**Water-based, non-toxic gel ink,**  
produced in Italy and compliant with  
European REACH and American TSCA  
standards. The refill's barrel is made  
of polypropilene.

—  
**Inchiostro gel a base acqua, atossico  
e prodotto in Italia, conforme alla  
normativa europea REACH e americana  
TSCA. Il tubetto del refill  
è in polipropilene.**

---

**all rights reserved maxema srl**  
**tutti i diritti riservati maxema srl**

The brands mentioned in this catalogue are the exclusive property of the respective owners. They are used for purely illustrative purposes and cannot be the object of any buying and selling transactions, under any circumstances.

*I marchi menzionati in questo catalogo sono di proprietà esclusiva dei rispettivi proprietari. L'utilizzo dei suddetti marchi è a puro titolo esemplificativo e non potrà mai, in alcun caso, essere oggetto di trattative commerciali.*

---

**creative direction**  
undesign.it

**still life**  
infinitostudio.com

**editing**  
elena ambrosio  
sara zampedri



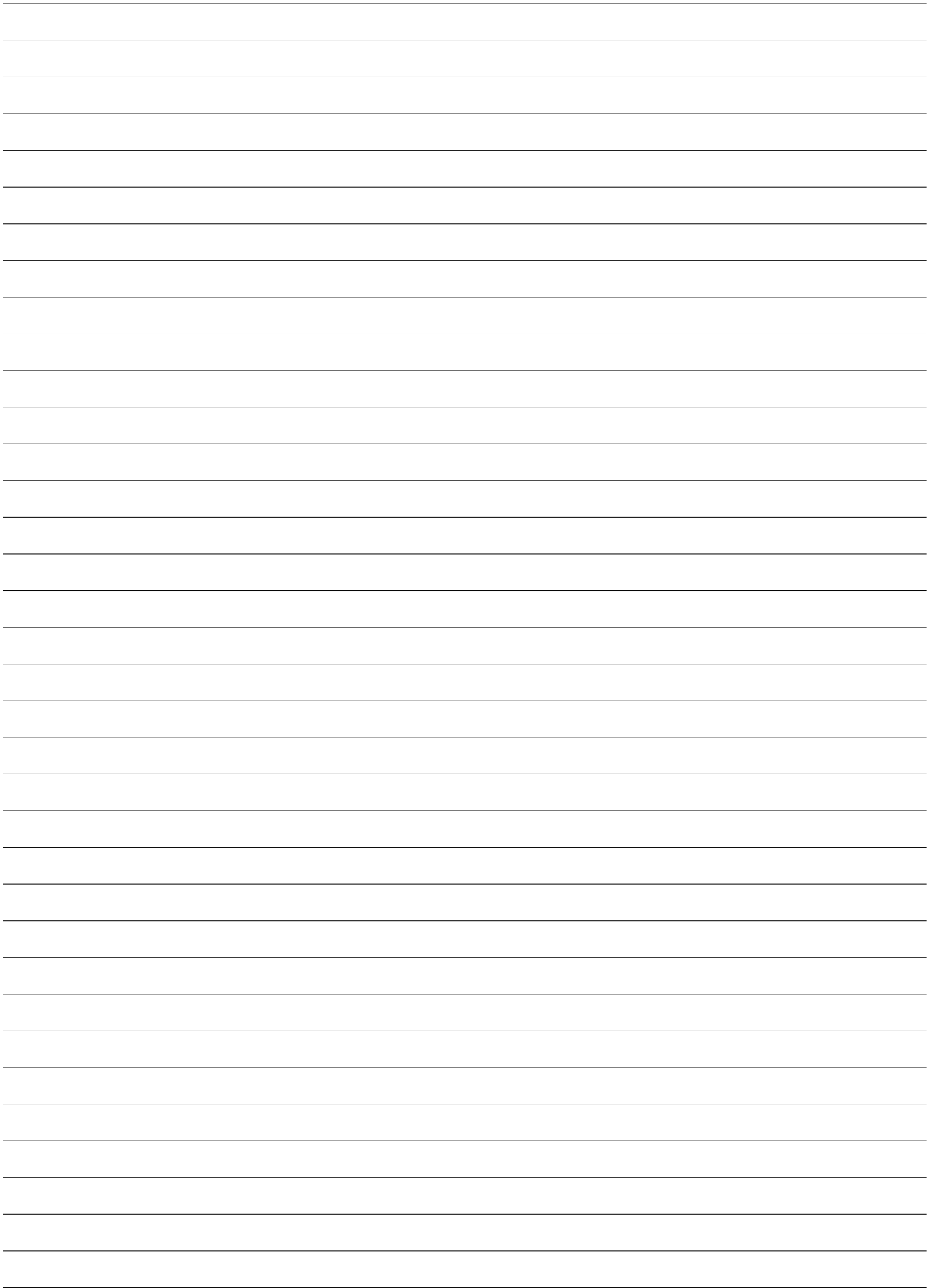



Printed in Italy on 100% recycled paper.  
Stampato in Italia su carta 100% riciclata.



Made  
in Italy



Prodotto  
in Italia

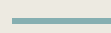

Fabriqué  
en Italie



Fabricado  
en Italia

